



Plusminus  $+_{-}$

VIBIA



# VIBIA

## Current catalogues



General Catalogue 2020-2021



New Collections 1



New Collections 2

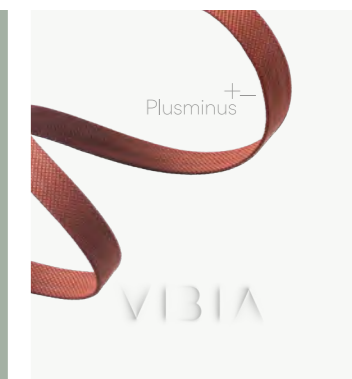

Plusminus

# Plusminus<sup>+ -</sup>

Design by Diez Office.

Plusminus is a versatile lighting system that takes the concept of the light rail to a new level. The conductive textile ribbon at its core allows for free placement of the luminaires and the creation of unique light solutions on the spot.





The fluidity  
of light

Equal parts easy and avant-garde, Plusminus harnesses the design of a belt in a groundbreaking lighting concept that merges materiality and light. Featuring a textural, fabric belt that conducts electricity, it enables light to flow through space. Plusminus provides professionals a powerful toolkit for creating personalised lighting effects and unique atmospheres with different luminaires via Vibia's digital platform and click-and-connect functionality.



## Luminaire types and lighting effects



### Sphere

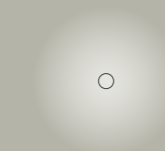

**360° Diffusion lighting** distributes light equally in all directions (360°). It attracts a relaxed gaze towards the point of light, and creates a calm, very comfortable atmosphere. The light sphere bathes all surfaces of the space, producing a peaceful, richer and extremely homogenous ambience.



### Semisphere



**Directed diffusion lighting** emits a soft light that generates low contrasts between the illuminated areas and the shadows cast. The opaque part of the shade helps to direct the light through the diffuser, providing illumination that is both peaceful and concentrated at the same time.



### Cone



**Directed diffusion lighting** emits a soft light that generates low contrasts between the illuminated areas and the shadows cast. The opaque part of the shade helps to direct the light through the diffuser, providing illumination that is both peaceful and concentrated at the same time.

### Spotlight



**Directed diffusion lighting** emits a soft light that generates low contrasts between the illuminated areas and the shadows cast. It is ideal for reading situations or when the light output is visible, as it does not produce glare.



**Accent lighting** emphasizes objects or architectural elements with intensive cones of light. Luminance contrasts attract the eye and bring the illuminated objects into the foreground. The light output is directed towards the object or architectural element and not towards the person, in order to avoid glare.



### Linear Diffuser



**General lighting** provides a high degree of uniformity on the horizontal plane and generates a first layer of illumination on which to add more specific lighting applications. It generates soft shadows and subdued brightness in which the space and its component elements do not display visual hierarchies.



### Linear Low UGR



**High-efficiency, low-glare general linear lighting** offers medium brightness and clarity of forms. Direct illumination, extended beam and luminaire performance enable installations with high-energy efficiencies and low-glare levels below UGR<19.

**High-comfort, low-glare general linear lighting** provides high levels of illumination and comfort with UGR levels below 19. It is also ideal for work or meeting areas.

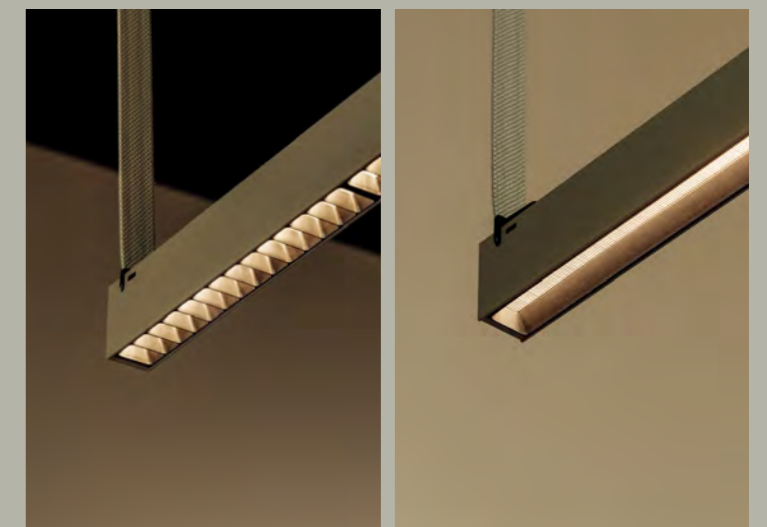



## Easy connection Fix / Click / Connect

Each belt, which can be cut as needed, accommodates multiple luminaires and operates with simple plug-in technology for unparalleled ease of installation and connection. The belt offers adjustments in tension from taut to relaxed as well as click-and-connect functionality, snapping into a buckle attached to each luminaire.





## Shaping Atmospheres

Endlessly versatile, Plusminus offers the freedom to combine different levels of diffuse and focused illumination as never before to create a unique atmosphere in any interior.

Design a space by drawing with the belt, conducting light to the right place while evoking an emotional response and sense of wellbeing.

Visual Hierarchy  
Raining Light  
Reimagining Spaces  
Framing Space  
Defying Gravity  
Flowing Pendants  
Creative Canopy Connection  
Suspended Animation

## Visual Hierarchy

Plusminus's revolutionary belt design provides a powerful toolkit for reimagining spaces.

Combining multiple lighting effects and placing light precisely where needed, it creates visual hierarchies in any space.

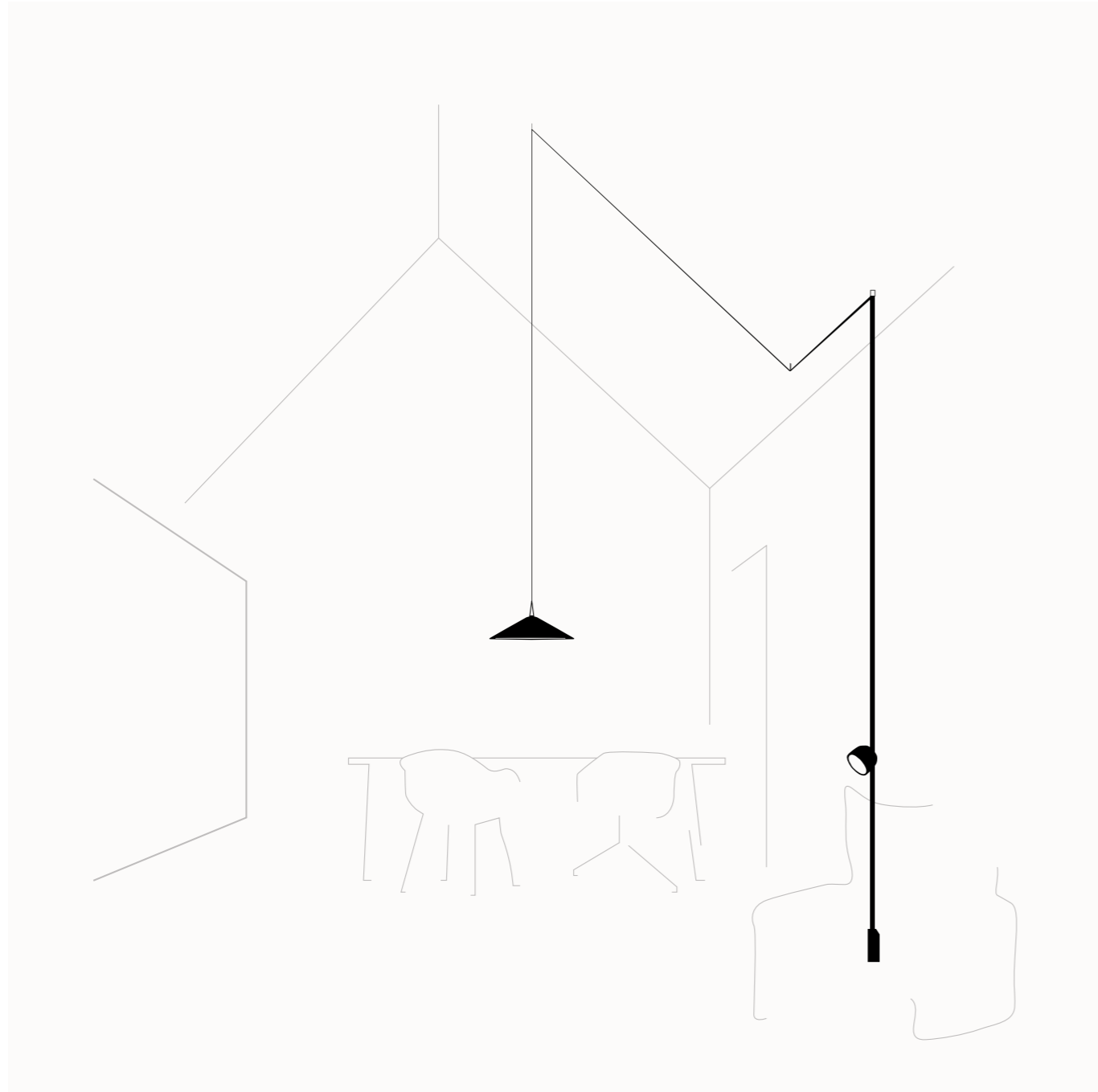





Place multiple lights in different positions throughout a space with just a single electrical connection.

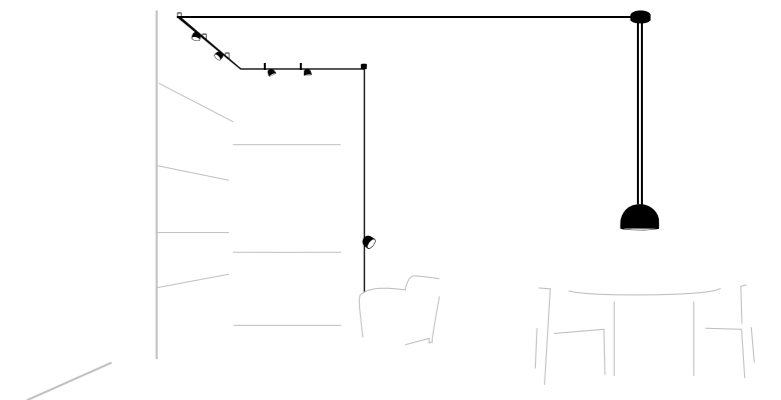



An invitation to position light without limits, Plusminus accommodates any kind of architecture—no matter how unique.

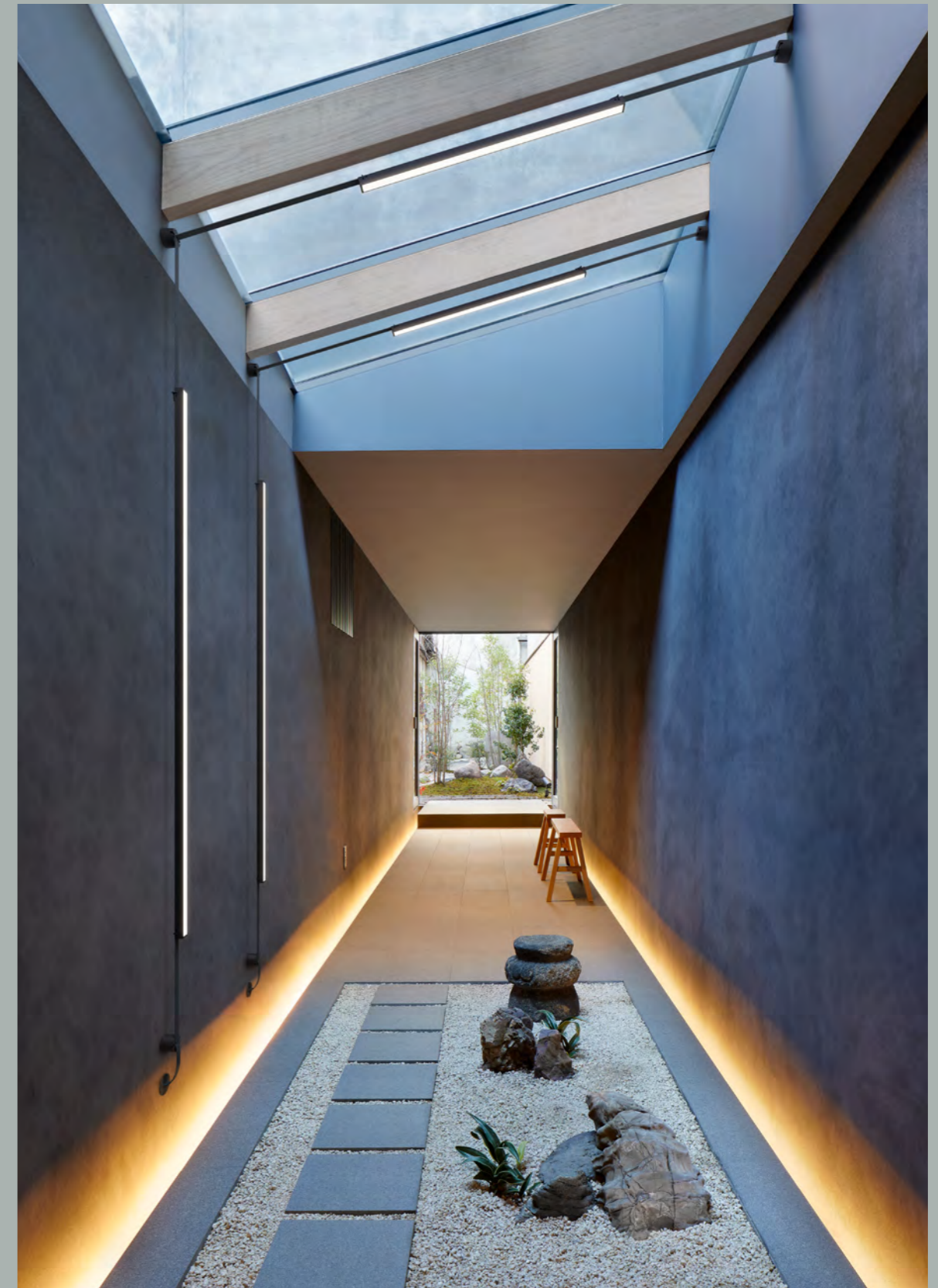
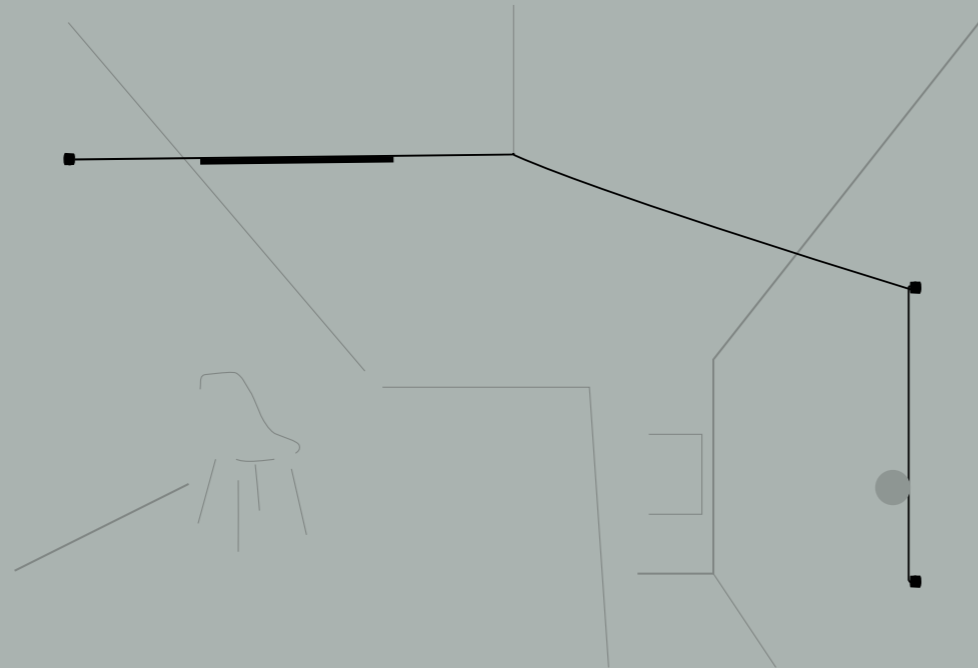

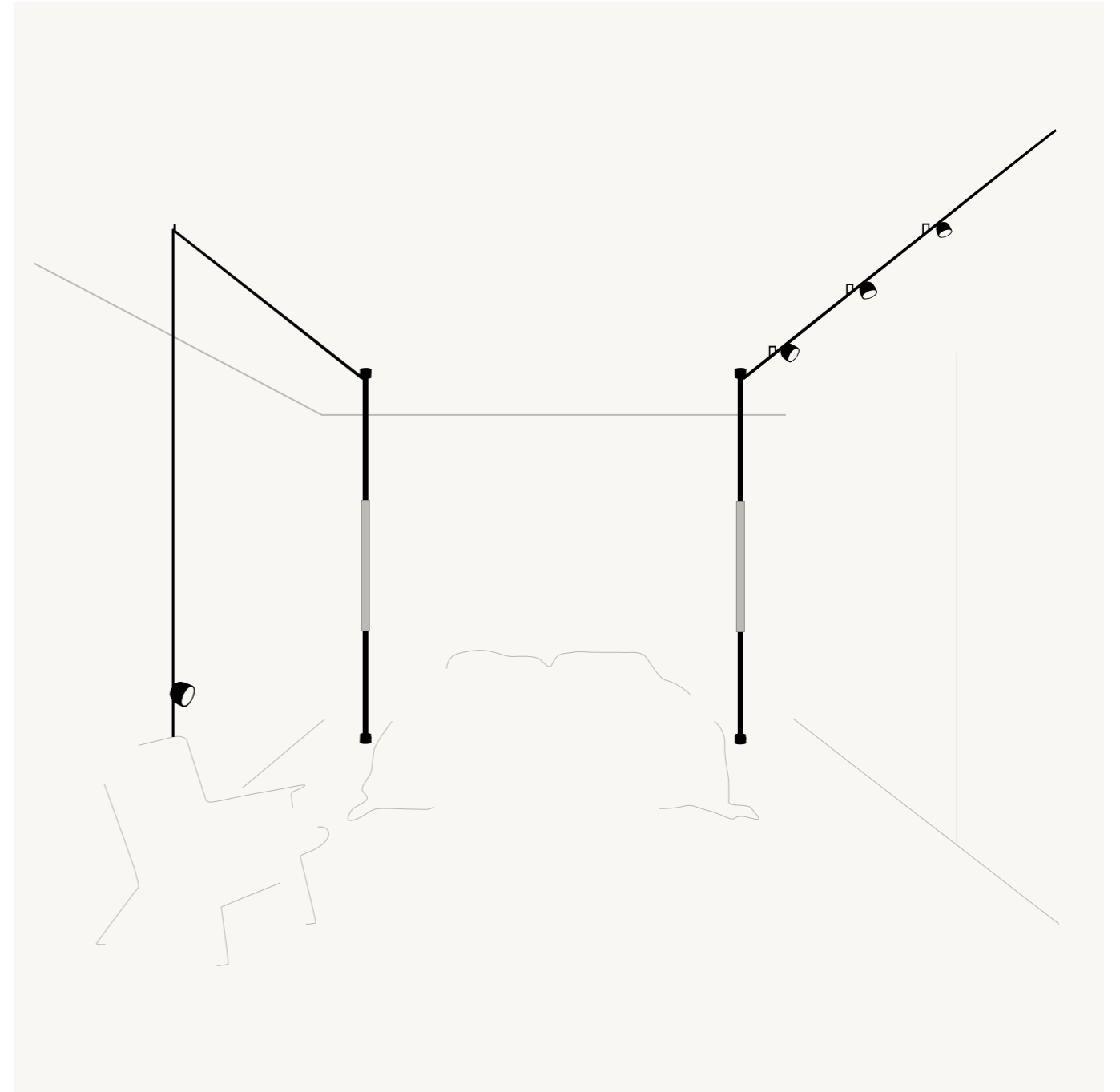



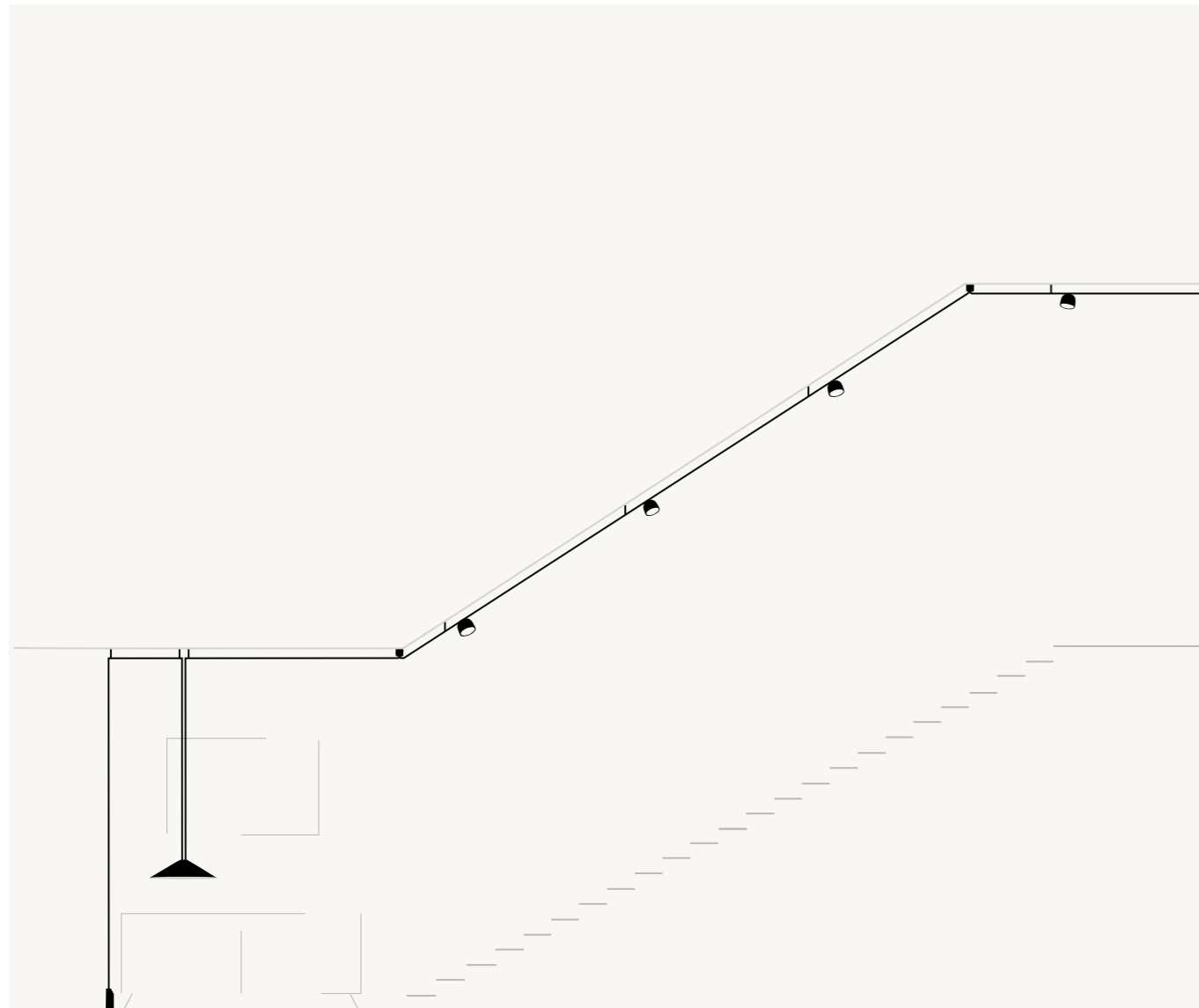

The fabric belt offers endless flexibility of use, conducting light across a range of ceiling shapes and angles.



## Raining Light

From a single spotlight positioned close at hand to a cascading installation of luminaires overhead, Plusminus's ceiling-to-floor possibilities create a stunning display of light in varying intensity and effect.



Plusminus's powerful design capabilities include constructing columns of light up to 30 meters high.



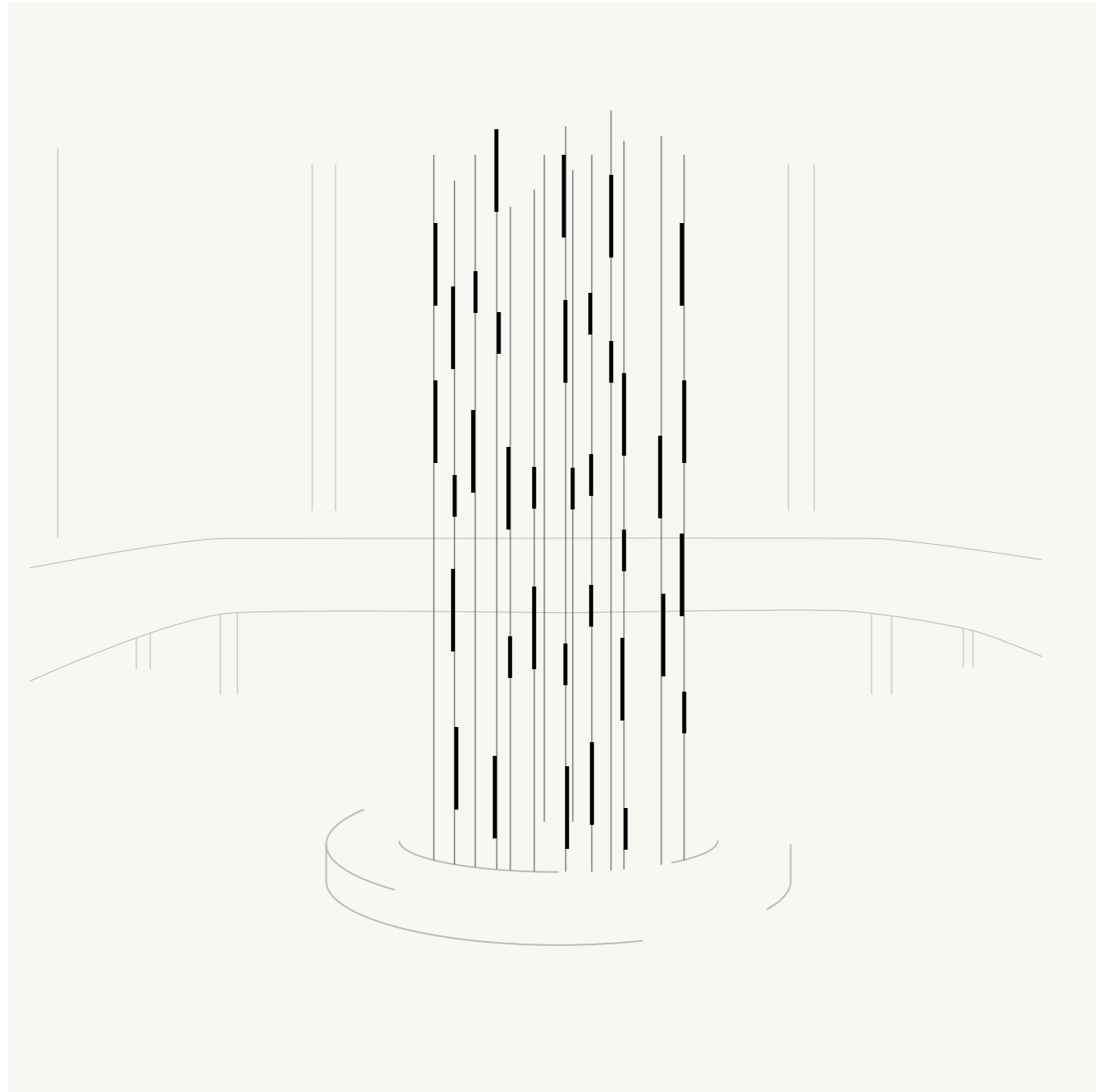







### Climbing the Walls

An innovative take on the wall lamp, Plusminus's fabric belt forms a linear architecture that hosts an array of lighting options—from a long row of accent lamps illuminating a hallway to sleek luminaires straddling opposite walls.

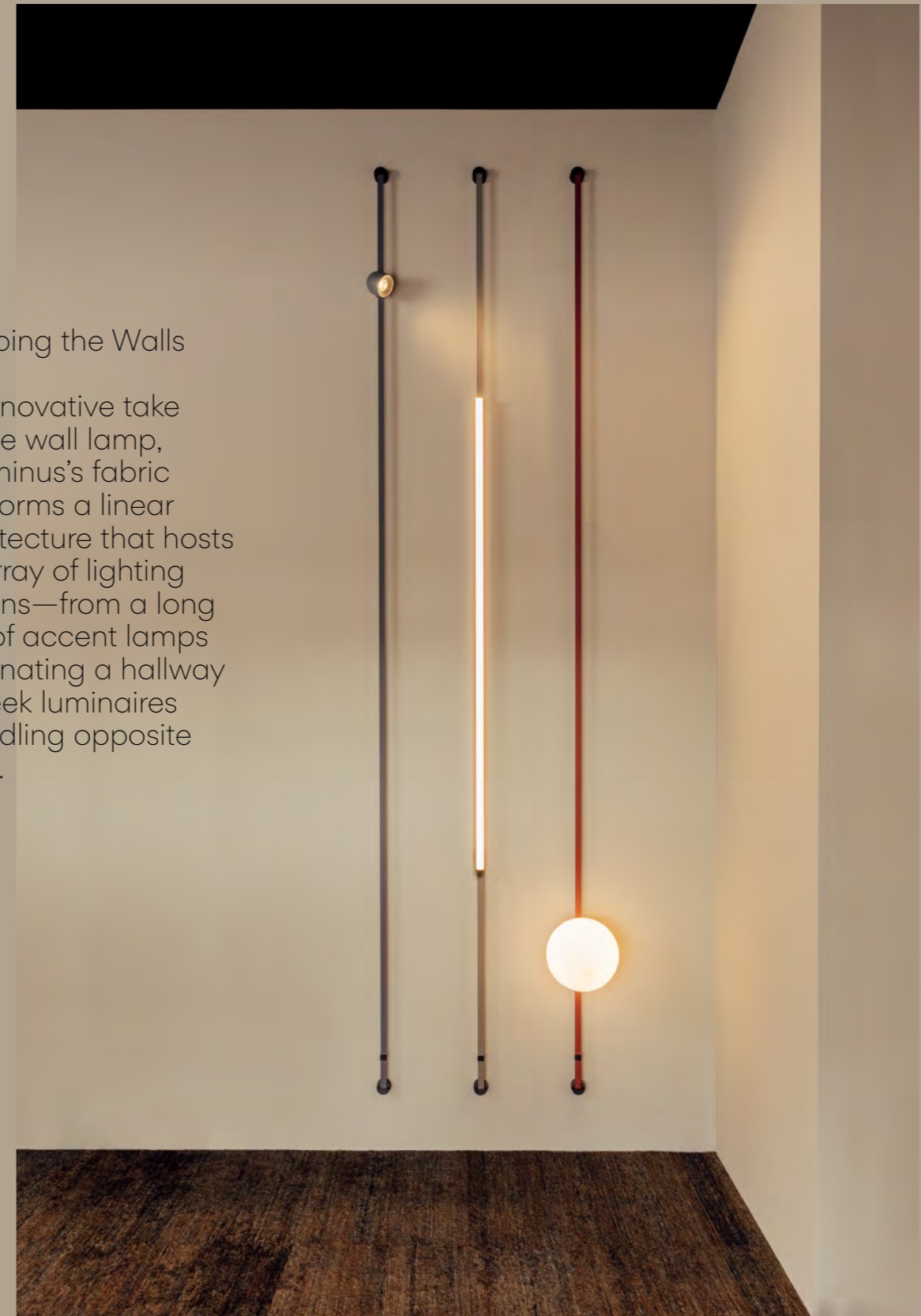



## Reimagining Spaces

Merging light and materiality, Plusminus introduces masterful new ways to delineate space. Tracing a slender outline, the fabric belt creates a contained area within an open layout, serving as an illuminated perimeter with minimal presence.







## Reimagining Social Spaces

Plusminus designs facilitate use of communal spaces, encouraging effortless interaction and movement.

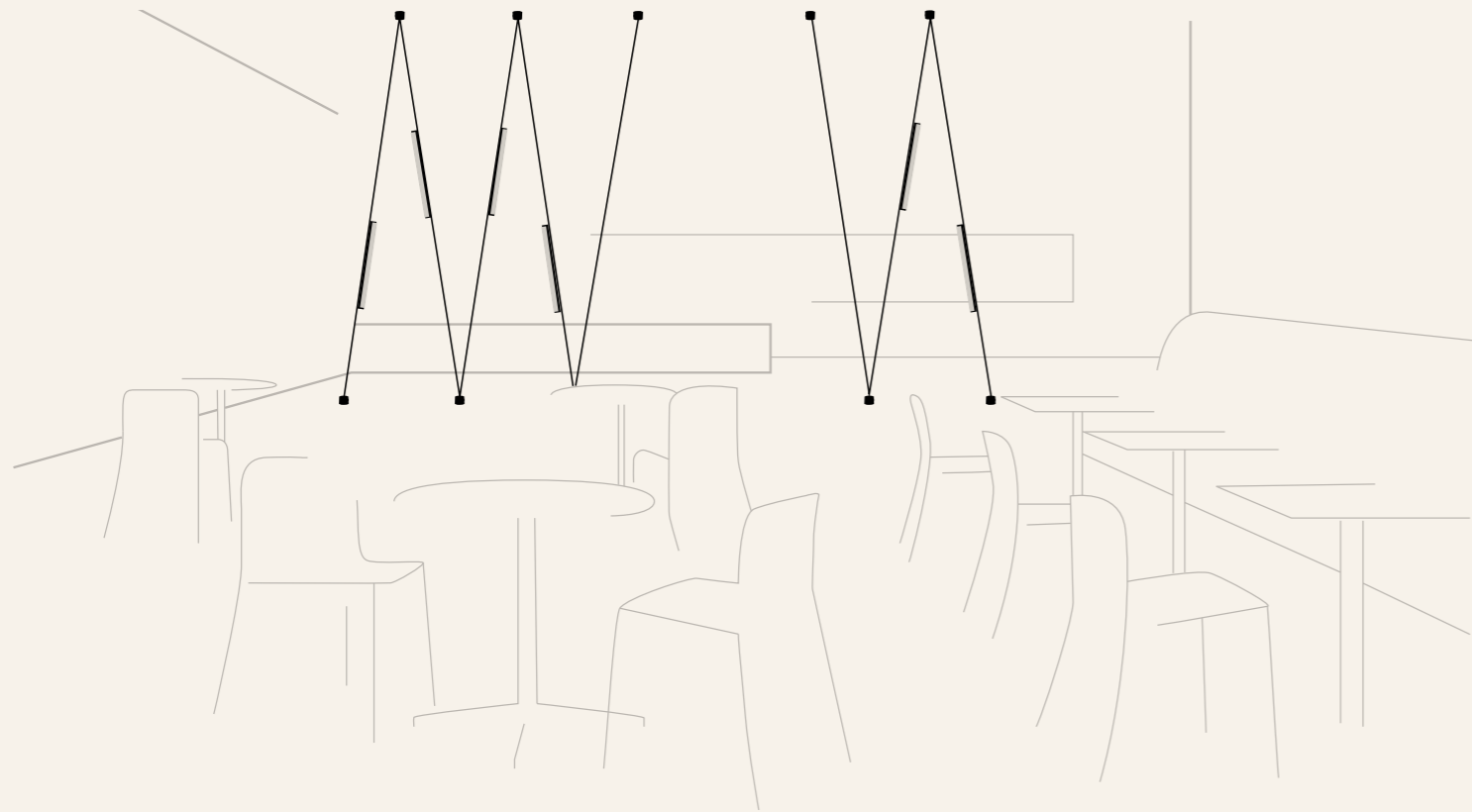

## Rethinking Workplaces

Innovative configurations create space for collaboration, interaction, and exploration, both delineating and enhancing workspaces.

## Framing Space

Plusminus's lean lines define an interior with precise transverse trajectories. Stretching from wall to wall, the belt evokes the effect of a false ceiling, reducing a room's volume and bringing light closer. With kinetic crisscrossed and zigzagged configurations or soothing straight lines, the luminaires appear integrated into the architecture.

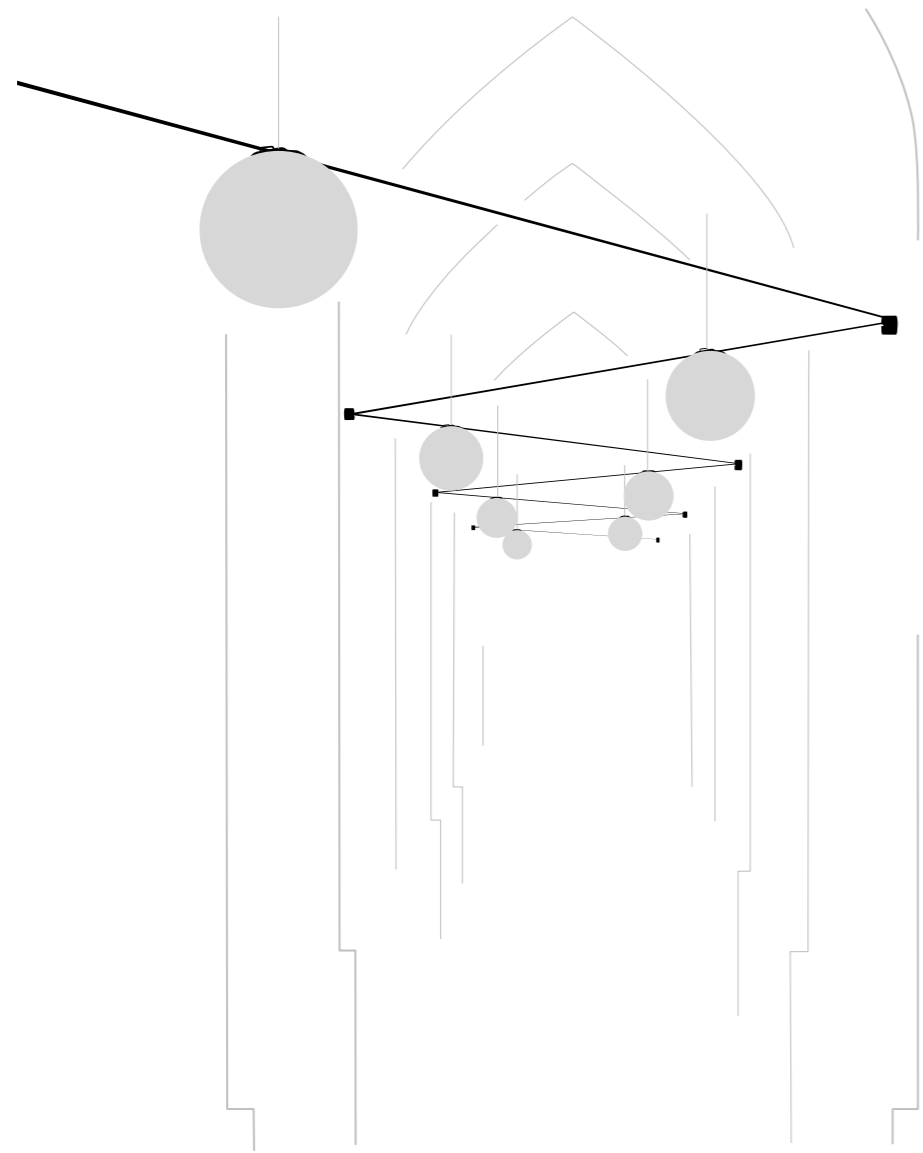

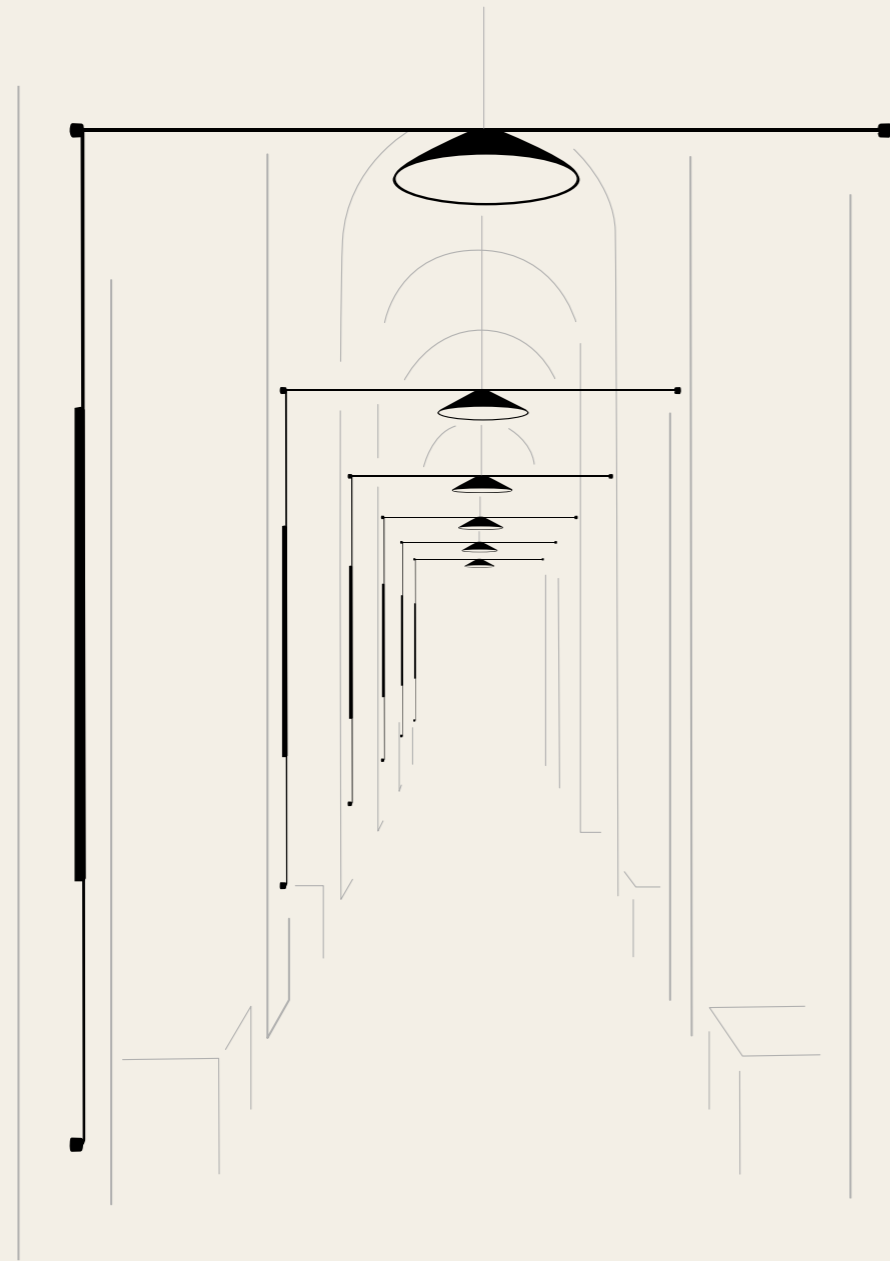





Plusminus' inherent adaptability provides the perfect solution for spaces that feature special architecture, scale, materials, or artwork.

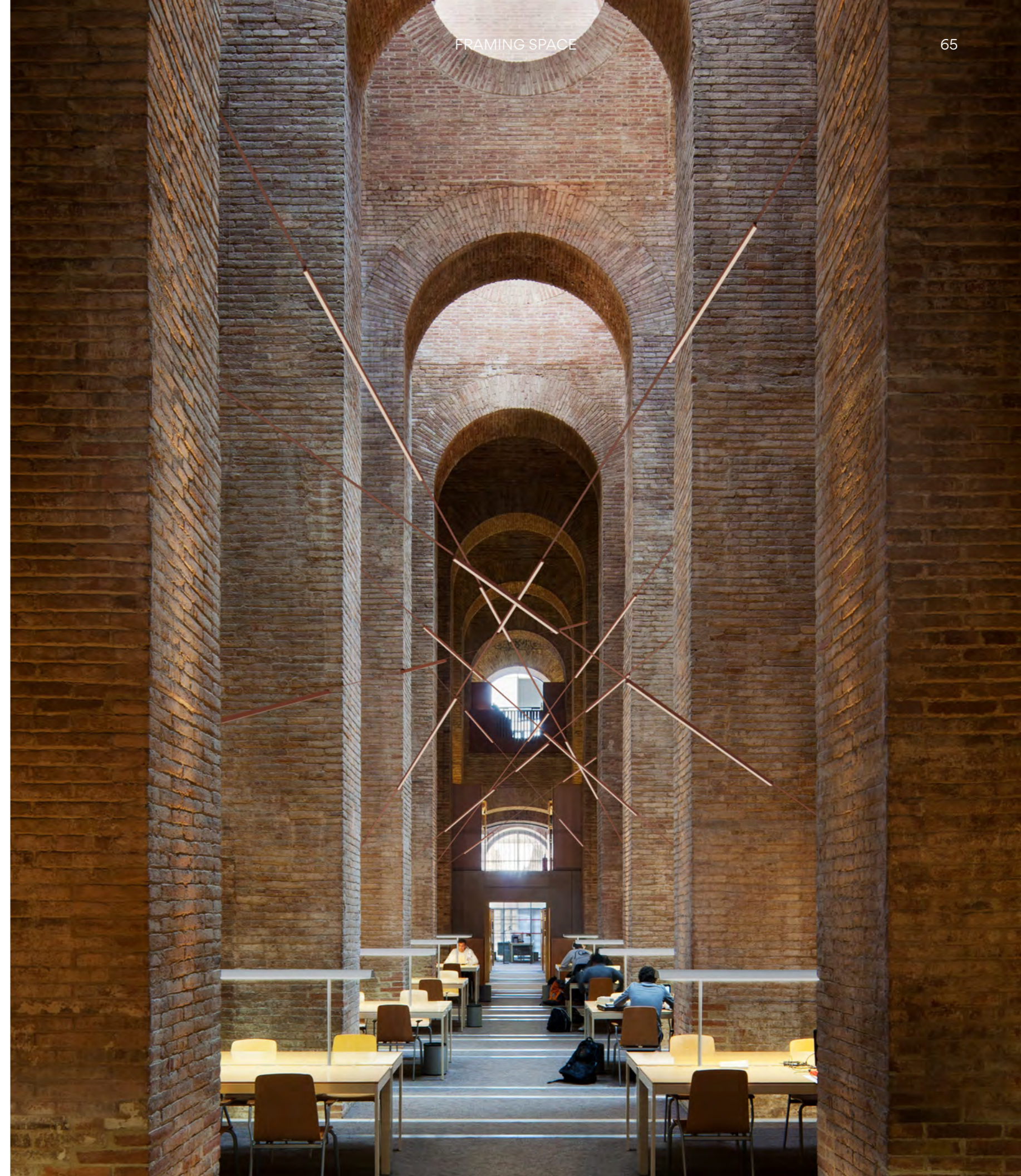

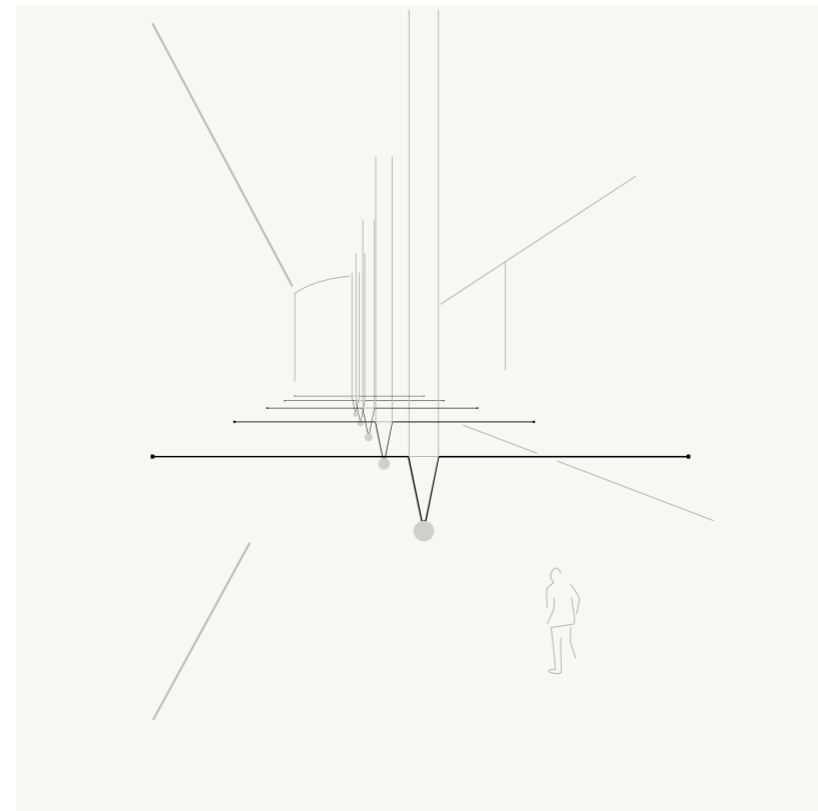
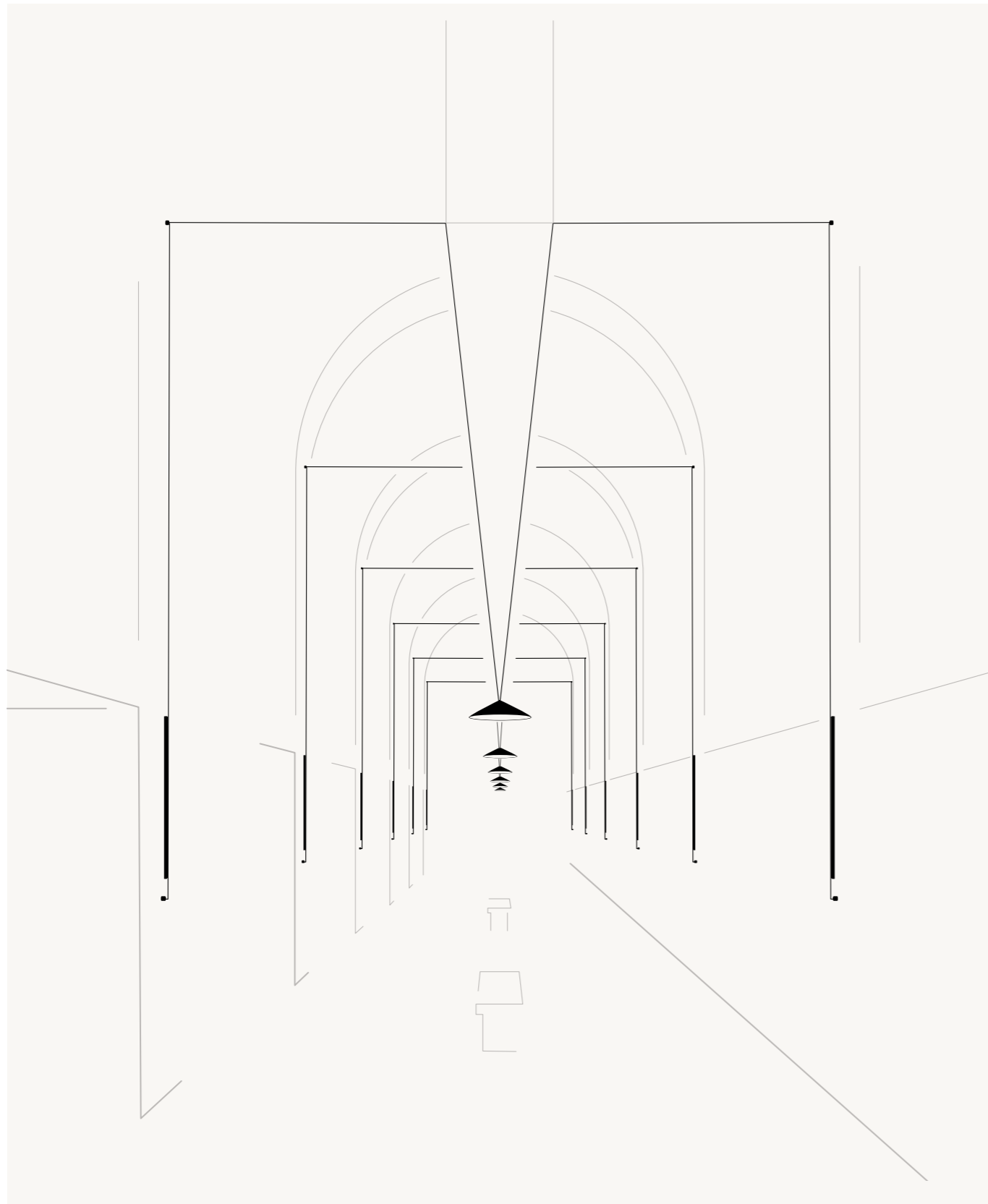

Plusminus's nearly invisible tensor wire introduces an element of intrigue to lighting. Lifting or lowering the belt, the cable creates varying degrees of tension that enables infinite configurations.

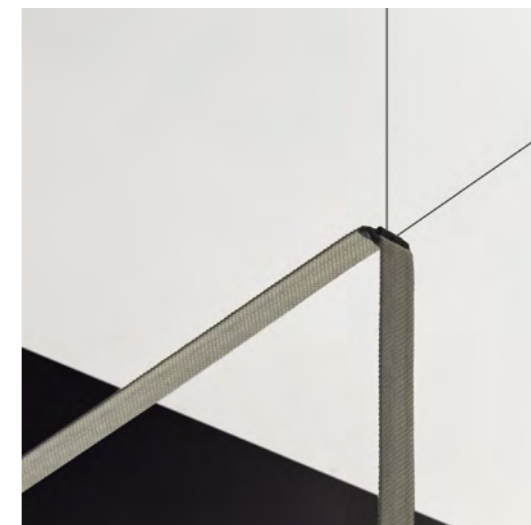



## Defying Gravity

Plusminus's nearly invisible tensor wire introduces an element of intrigue to lighting. The wire extends from the belt to the wall or the ceiling, quietly completing the luminaire's design while lending it the magical look of floating in midair in defiance of gravity.



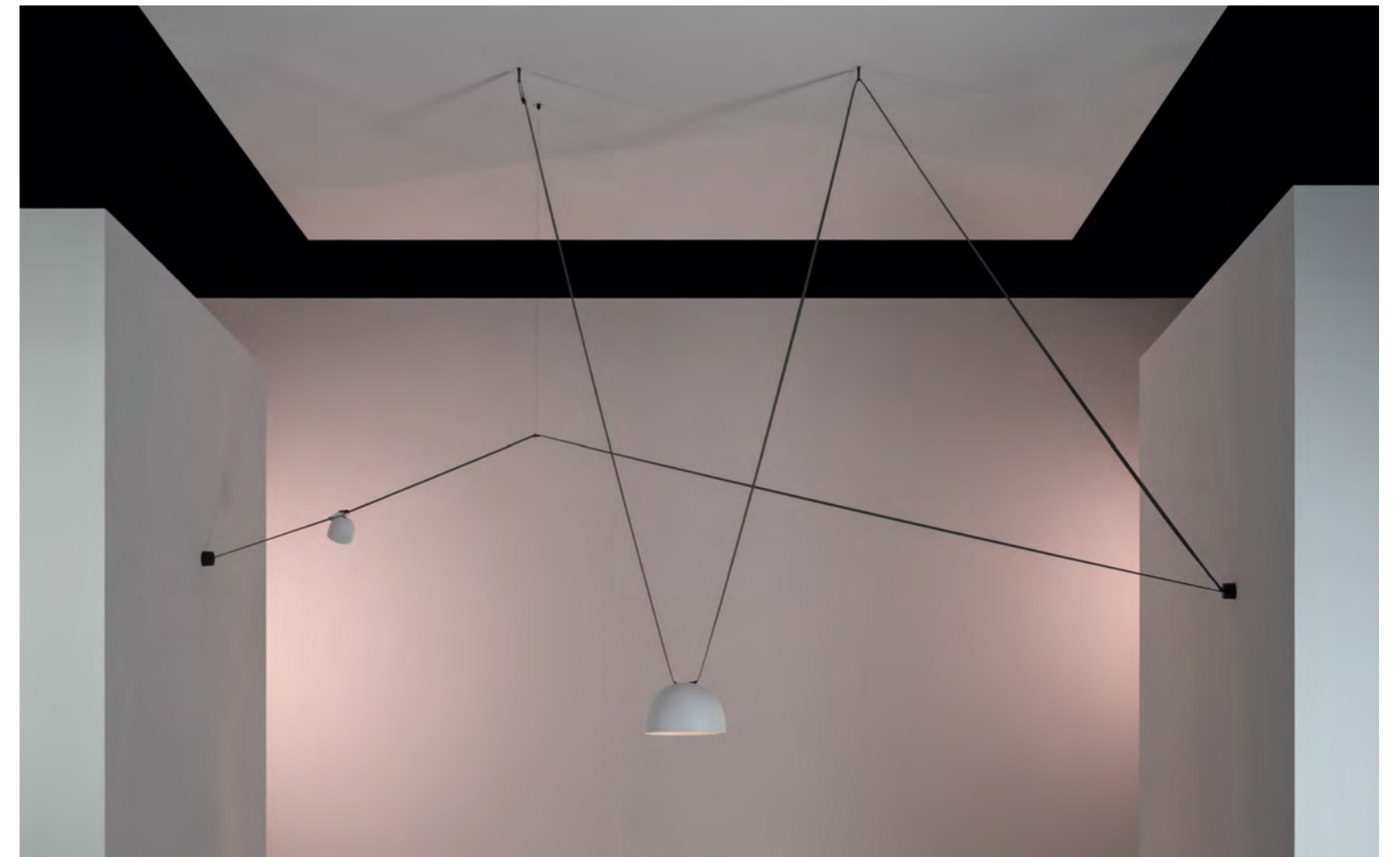
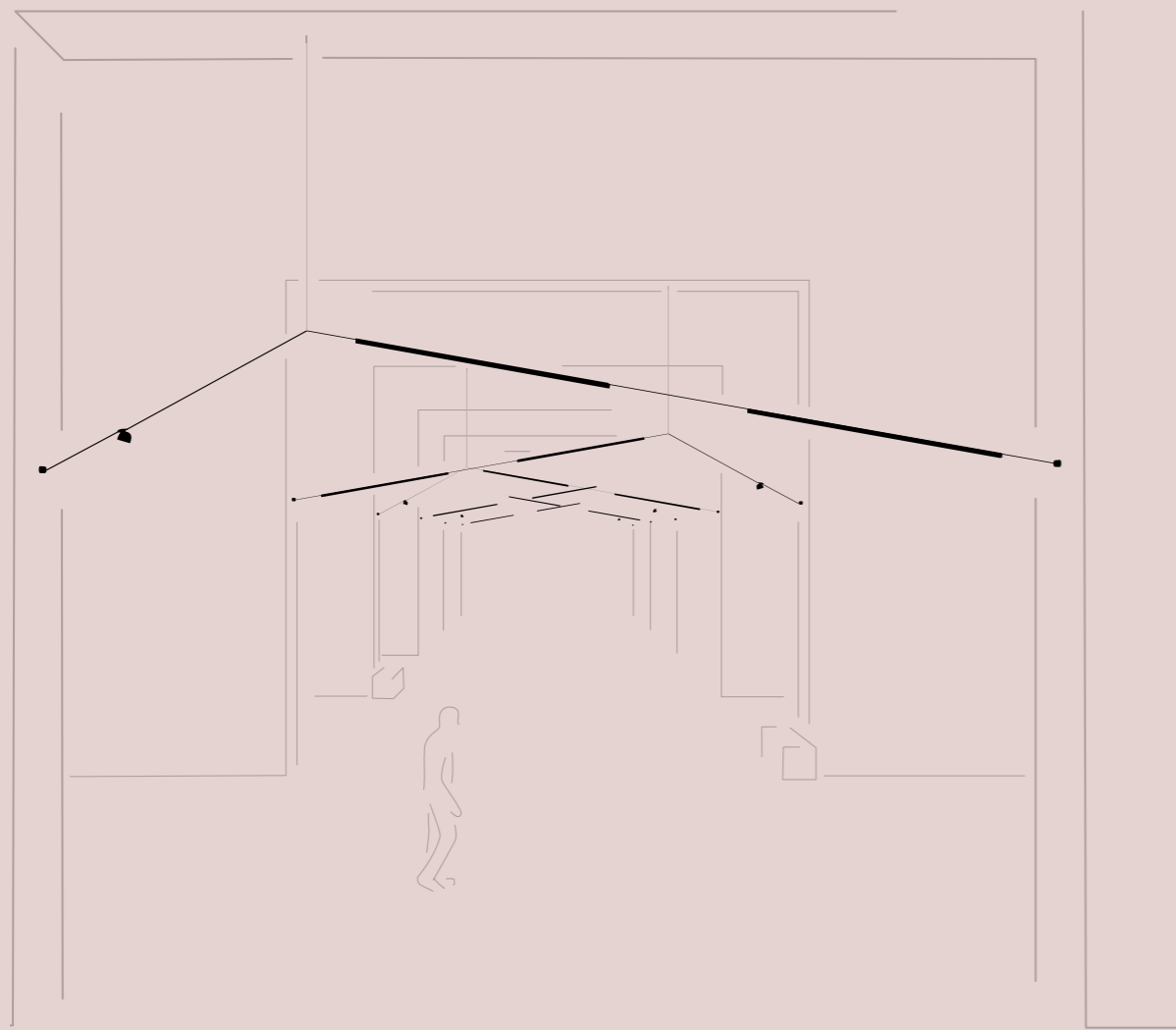

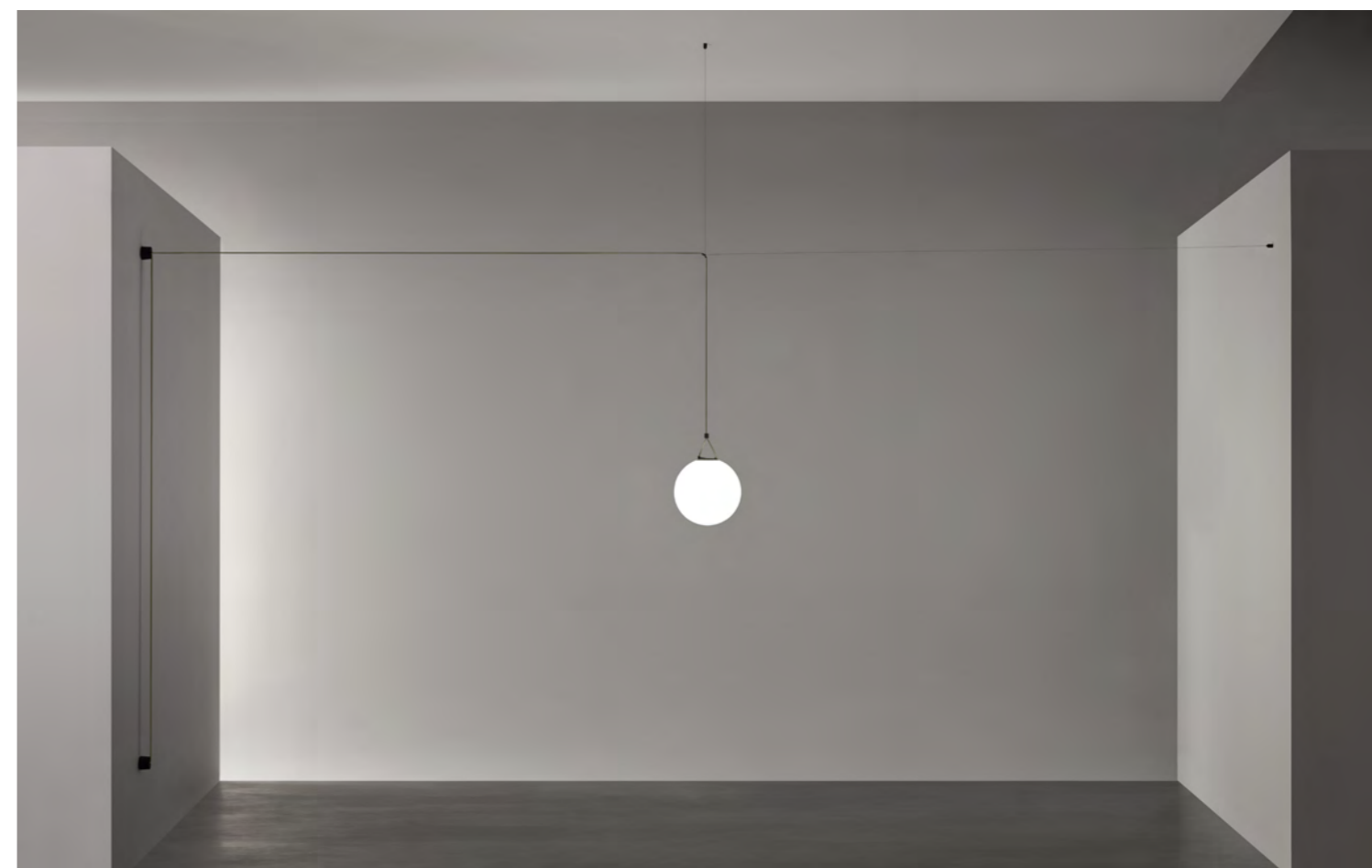

### Balancing Act

Wall-to-wall installations hang in a delicate balance with Plusminus's invisible ceiling tensor. Lifting or lowering the belt, the cable creates varying degrees of tension that enables infinite configurations.

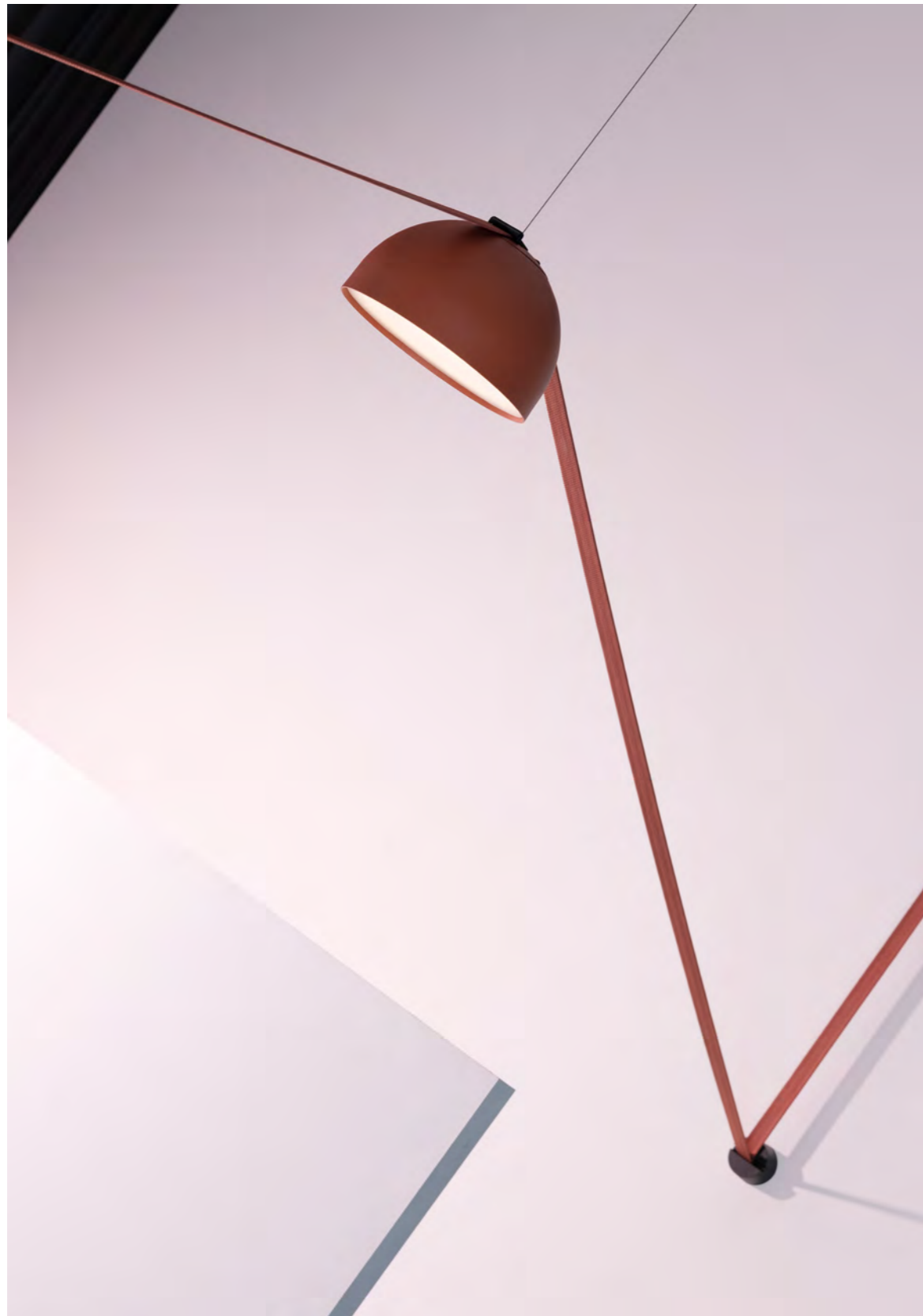



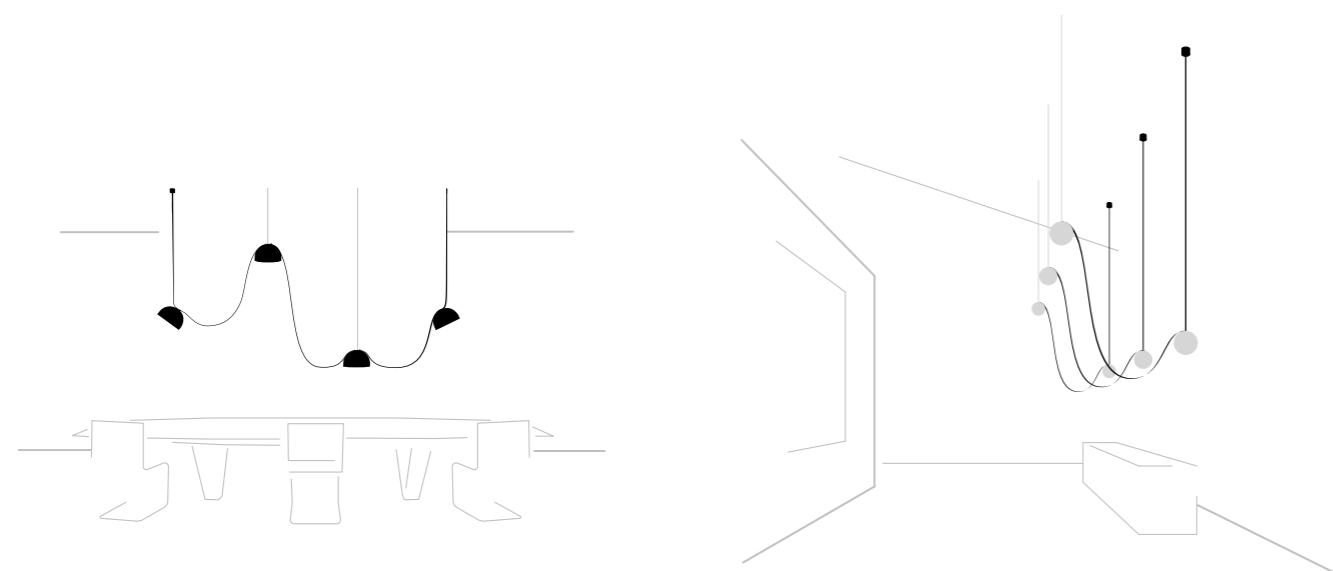



With the end cap belt's finish, the luminaire appears suspended in a seemingly impossible position mid-air, forming an eye-catching focal point.

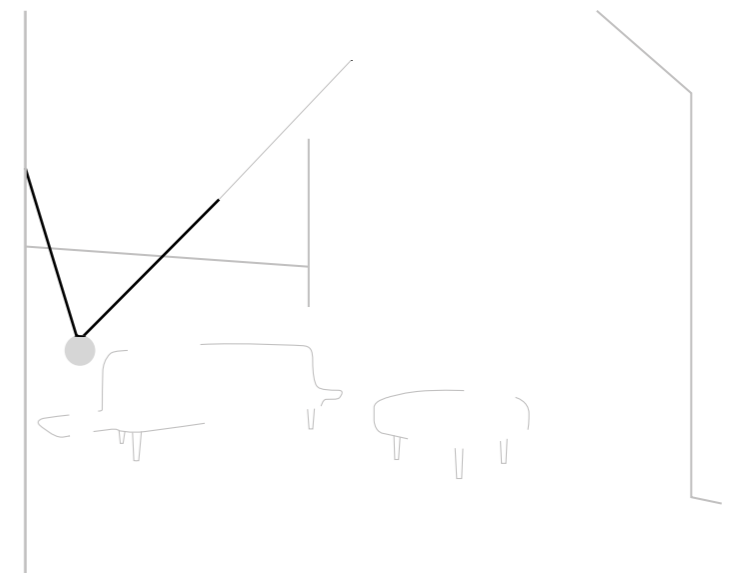
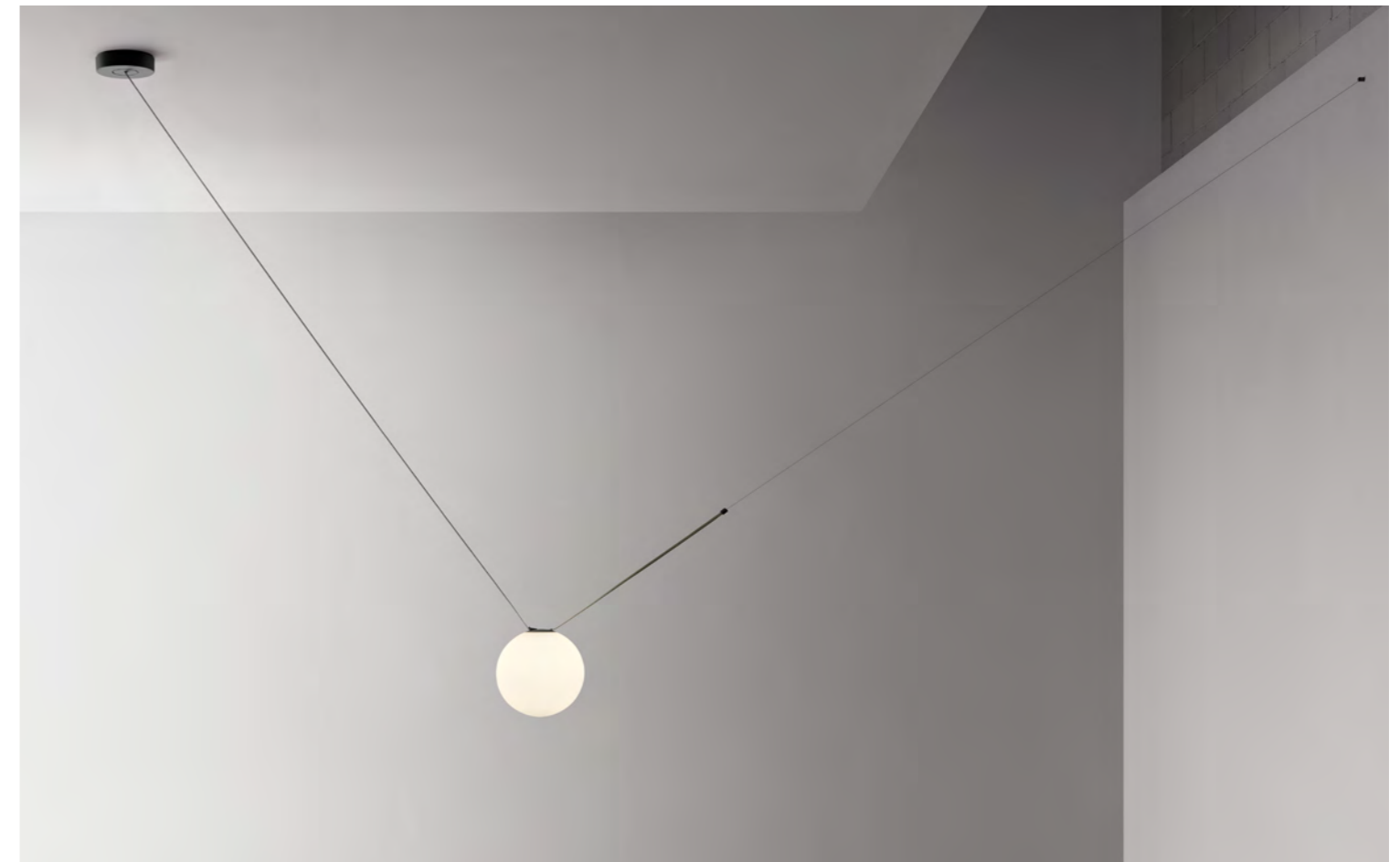

## Flowing Pendants

Defined by their flowing, continuous forms, Plusminus pendants provide endless possibilities for illuminating a space. Suspended overhead in silhouettes, soft and draped or taut and precise, their graphic presence creates distinctive ambiances.





“The Plusminus collection is a toolbox which, thanks to the wide range it contains, enables you to find solutions to an incredible number of lighting problems. I think architects and lighting designers today need investment certainty, and Plusminus offers that.”

Stefan Diez

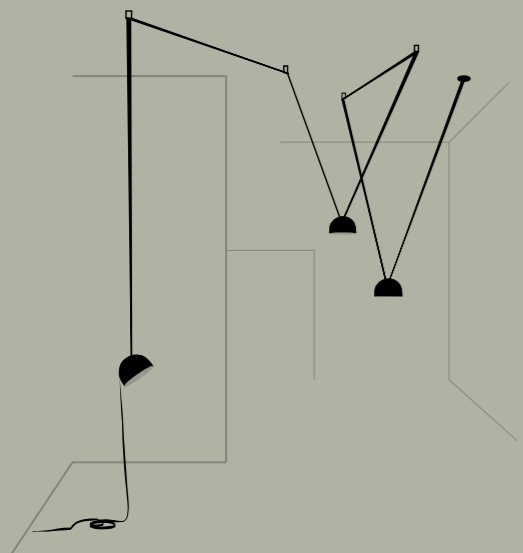

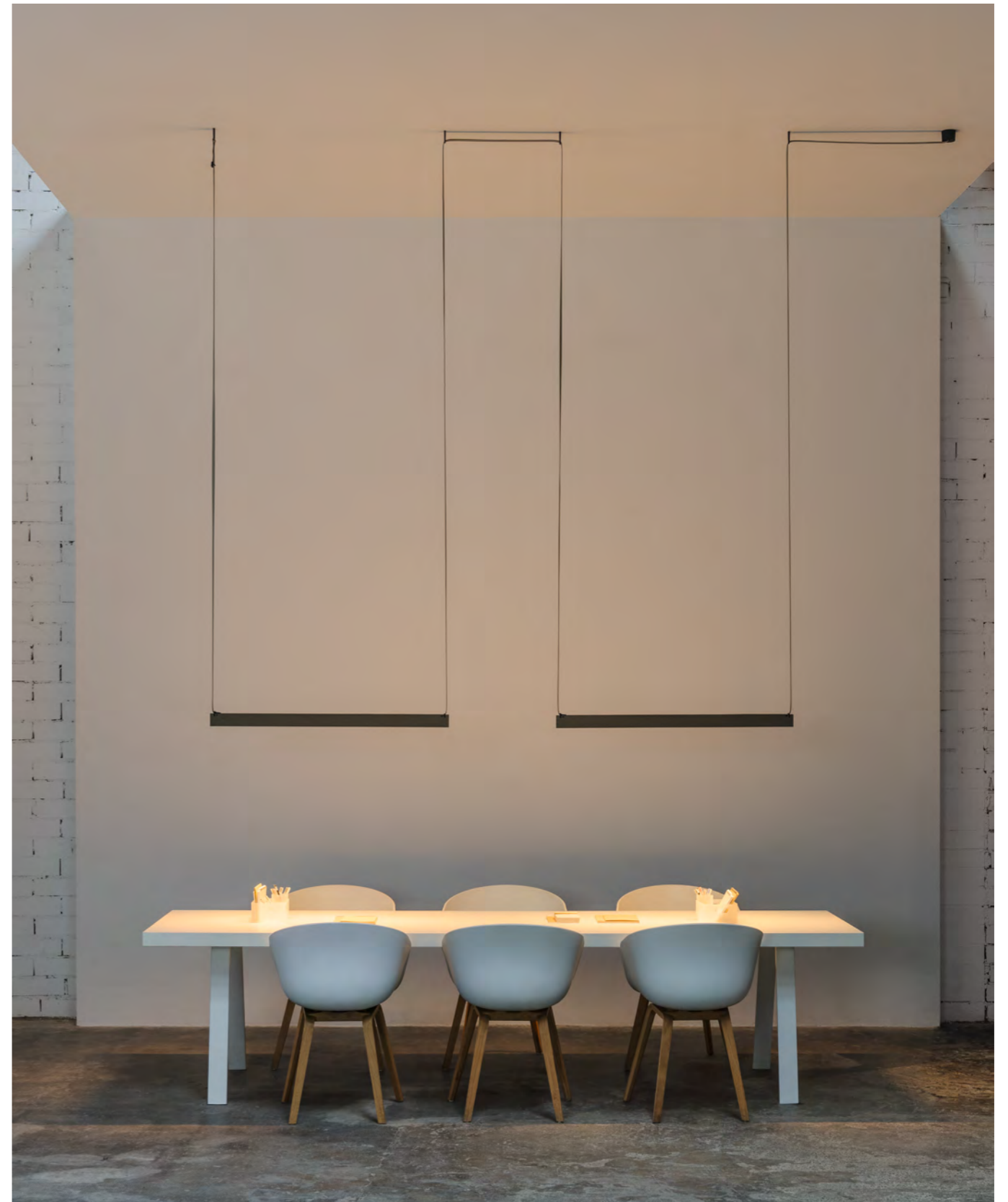
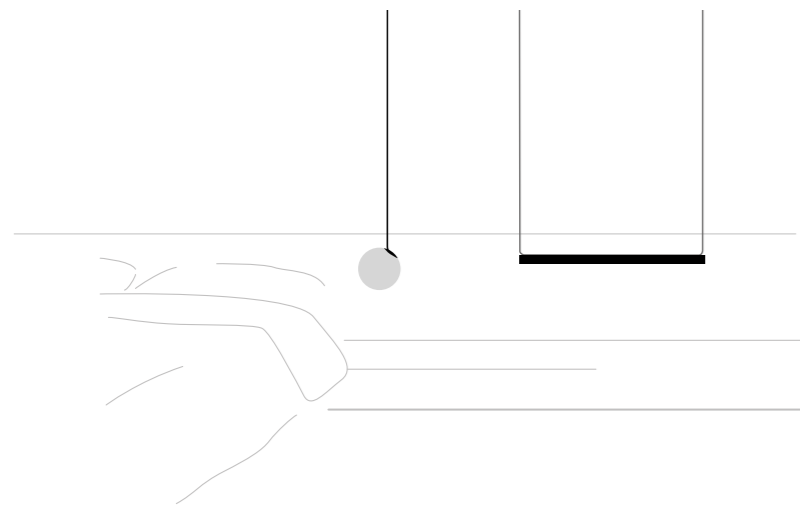
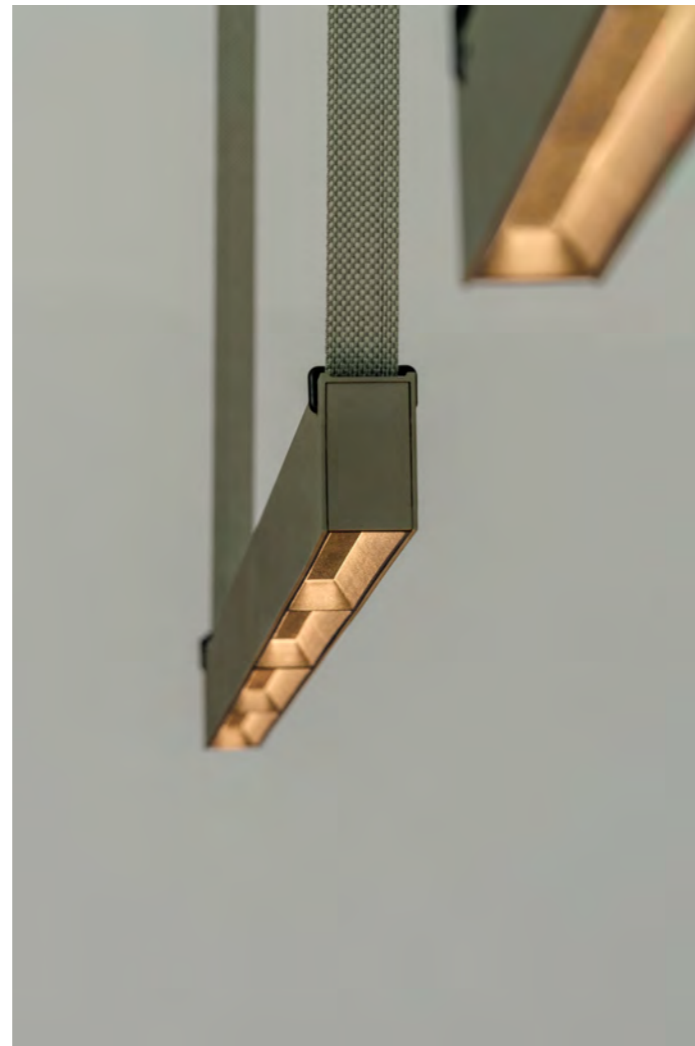





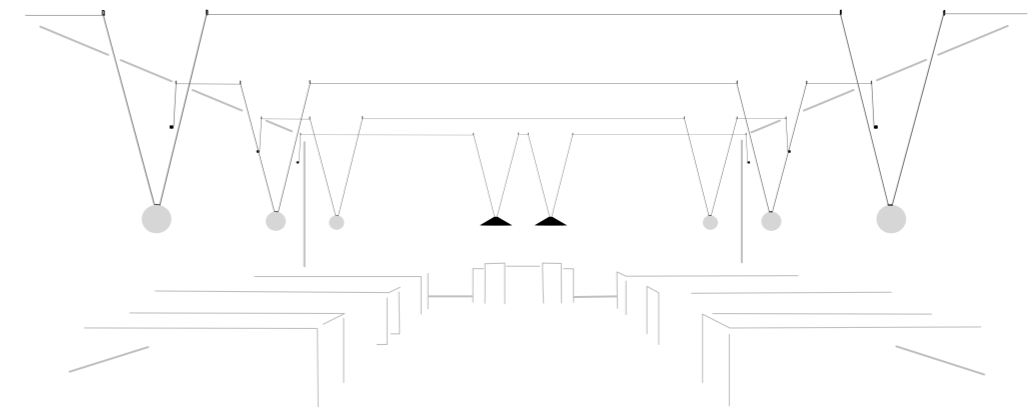
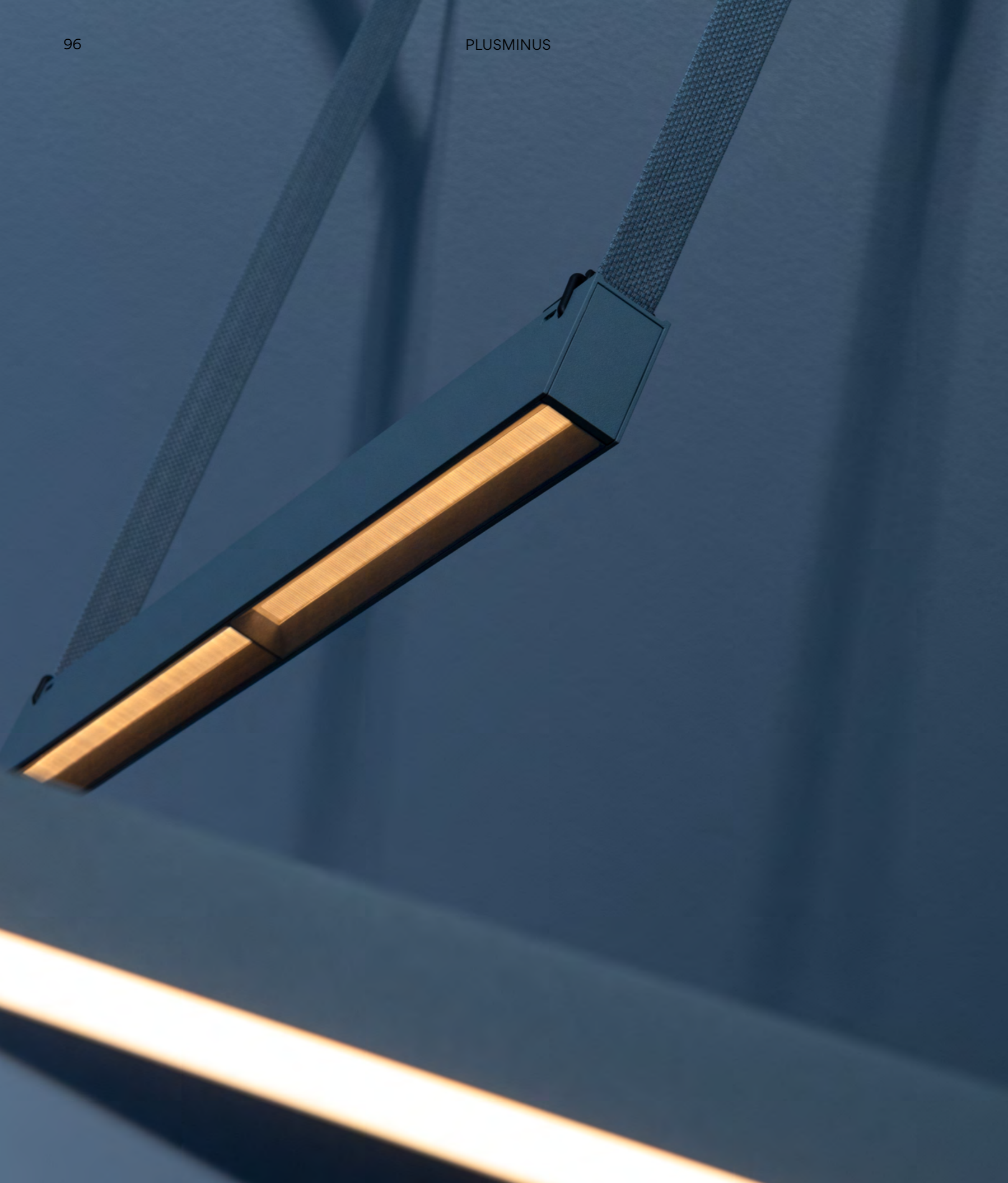



### Composing Light

Both object of beauty and high-performance lighting toolkit, Plusminus offers personalised atmospheres while doubling as striking visual sculpture.





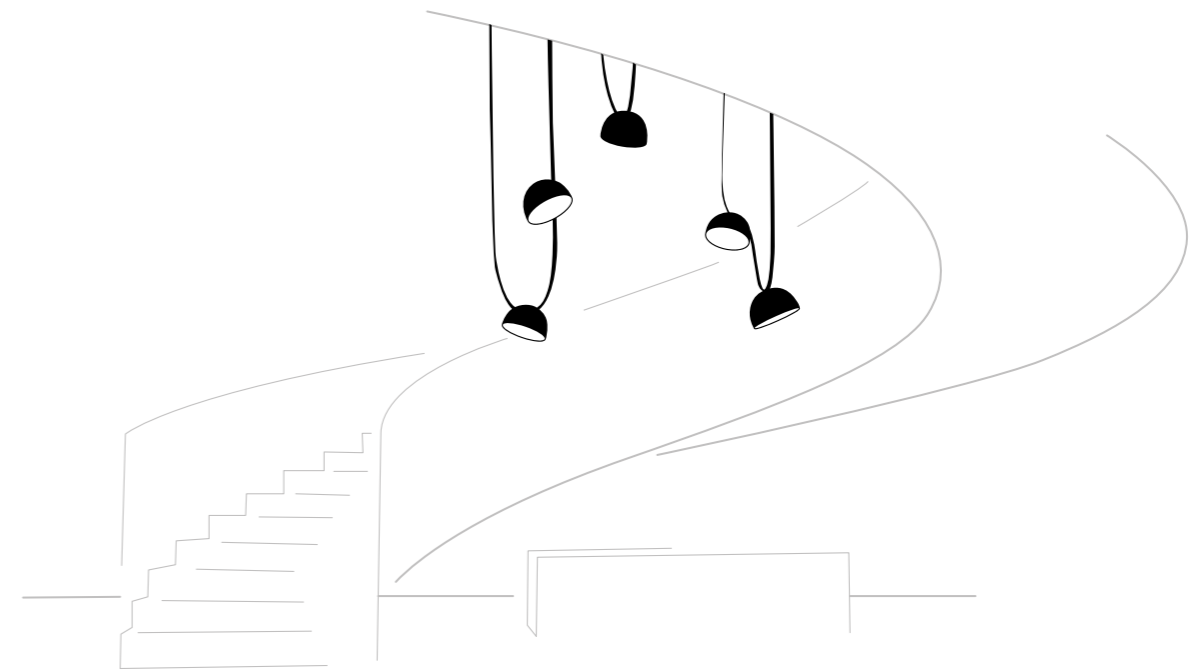











## Creative Canopy Connection

Plusminus reimagines the use of the canopy. The belt flows in and out of the canopy, establishing conductivity and electrical connection where needed, with creative configurations becoming an essential element of the design.



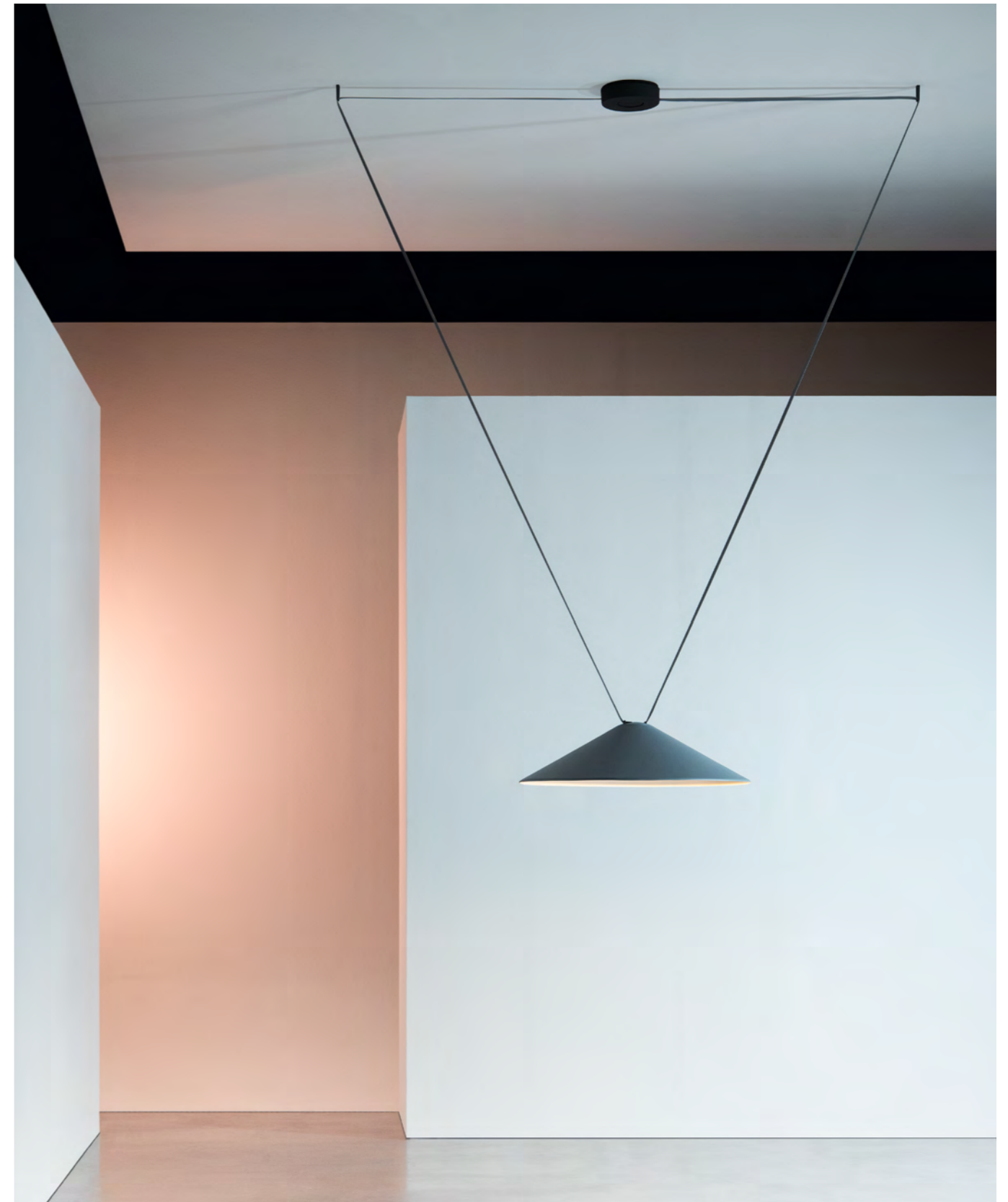



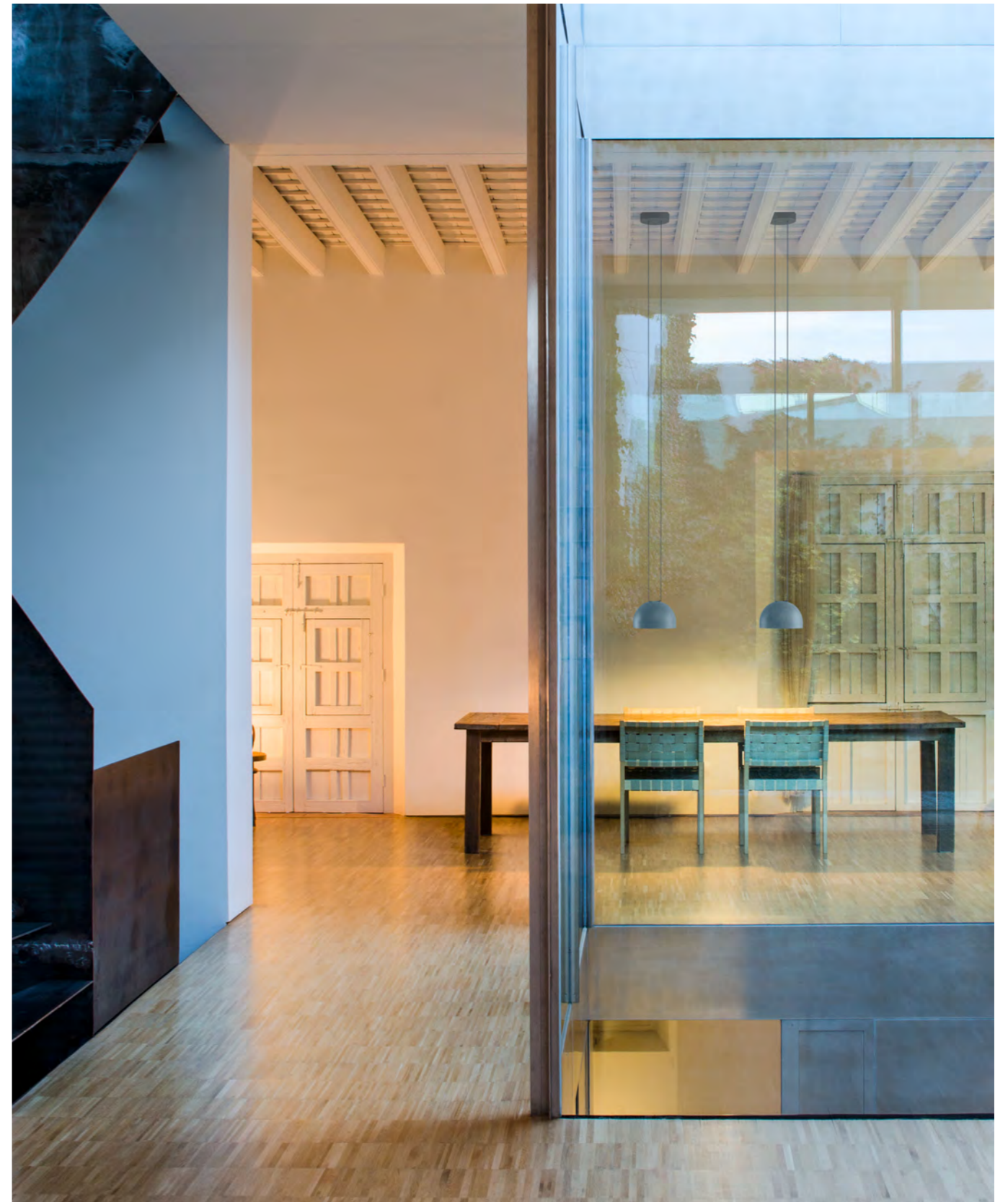



A surface canopy presents yet another opportunity to play with Plusminus, securing the belt in one spot while allowing it to flow freely across a space in countless configurations.

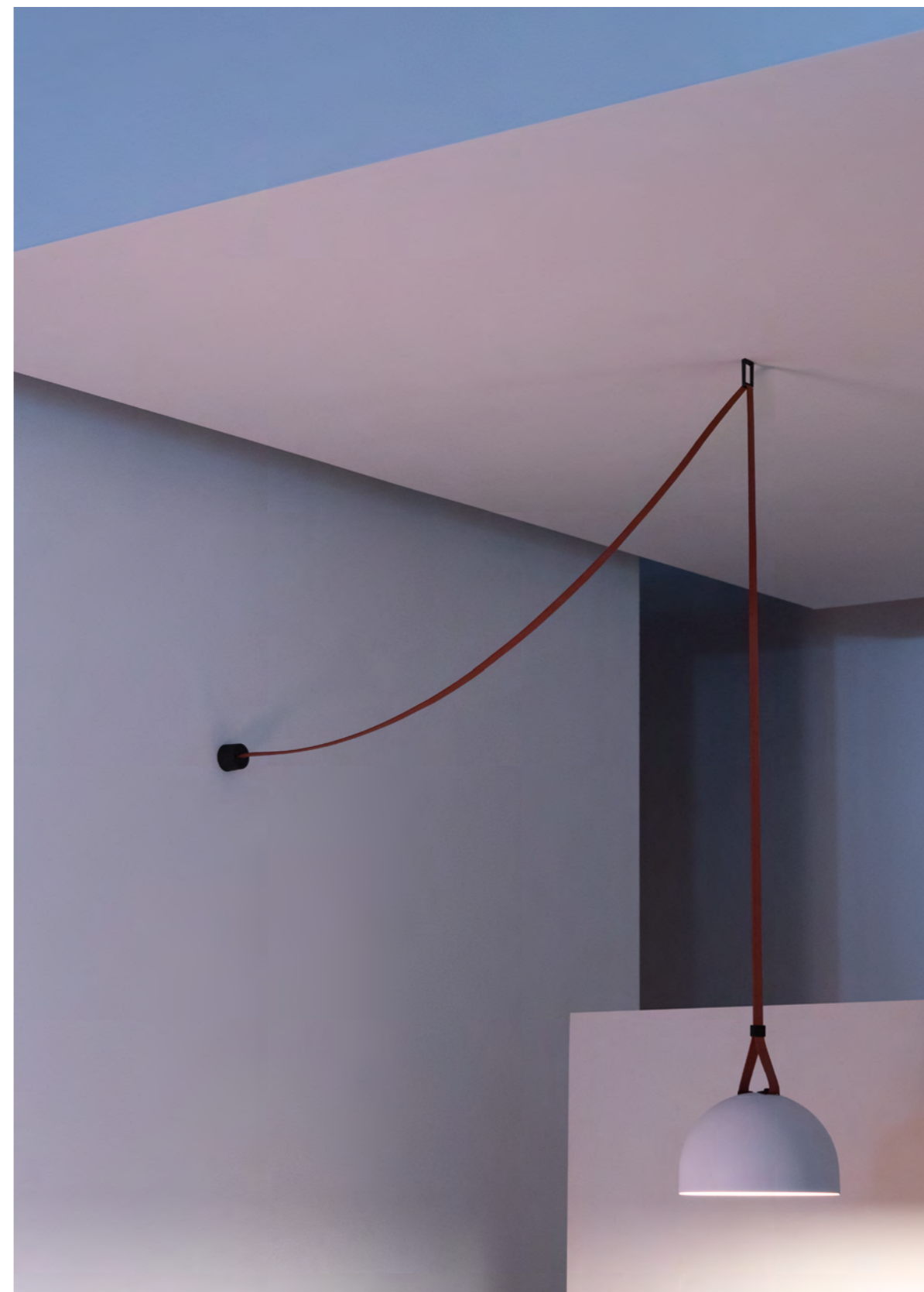

## Suspended Animation

Ceiling design no longer limits lighting options thanks to Plusminus. A bar suspended from the ceiling serves as both a sleek architectural feature and an opportunity for creative exploration.





Play with height and length  
to suit any setting and affix personalised  
belt designs for a one-of-a-kind look.





Bar length 2 m  
Tensor cables max. 5 m



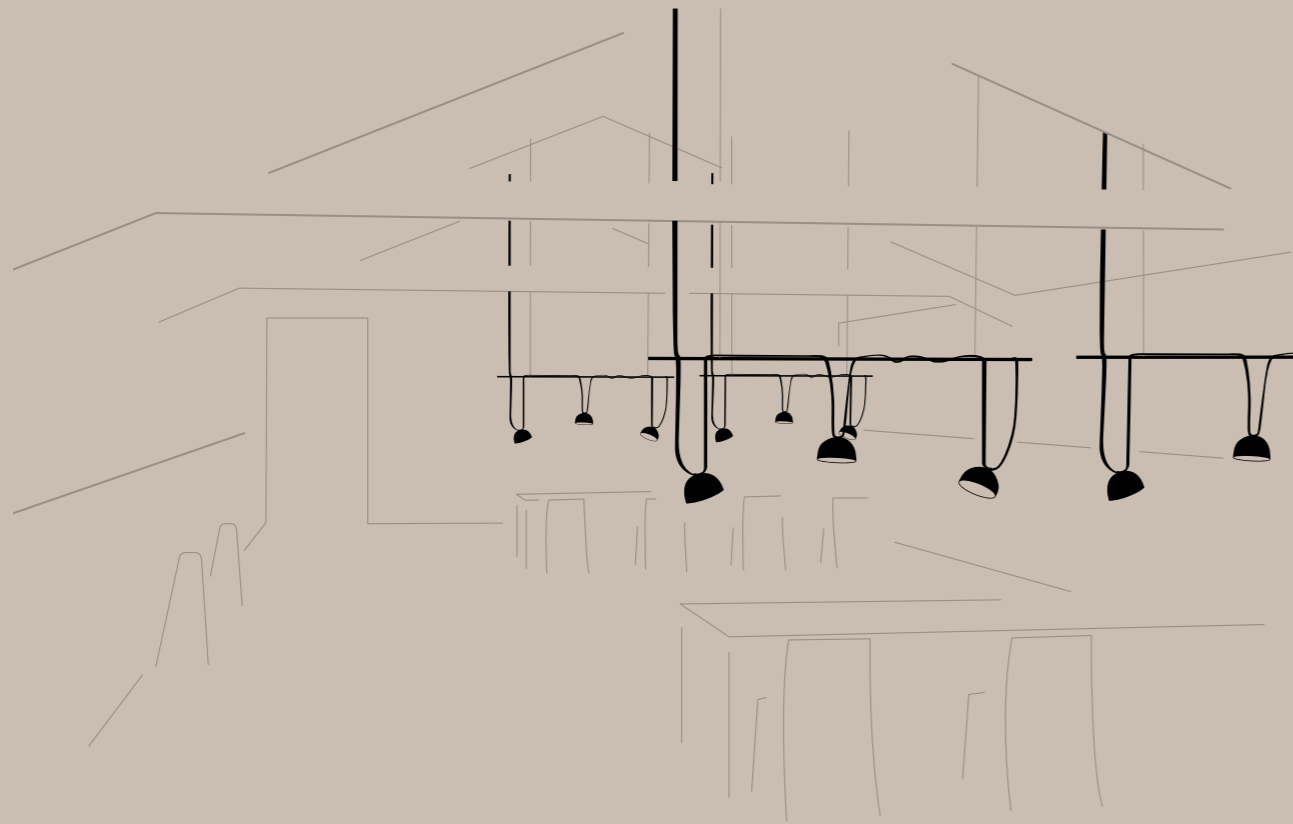

Sloped angles, wood or metal beams, and heating or cooling installations pose no problem for Plusminus. A sleek bar affixed to the ceiling provides an architectural platform for the belt, which wraps around it in a range of draped designs.





Detailed product information

## Belt

- 
- Black
  - Terra Red
  - Blue
  - Green
- 

Maximum 30 meters length  
per electrical connection point.

FIRE HAZARD TESTING.  
Fulfills the requirements of:  
standards EN 60695-2-10:2013;  
EN 60695-2-11:2015;  
EN 60695-2-12:2011 / A1:2014

Belt: Polyester.

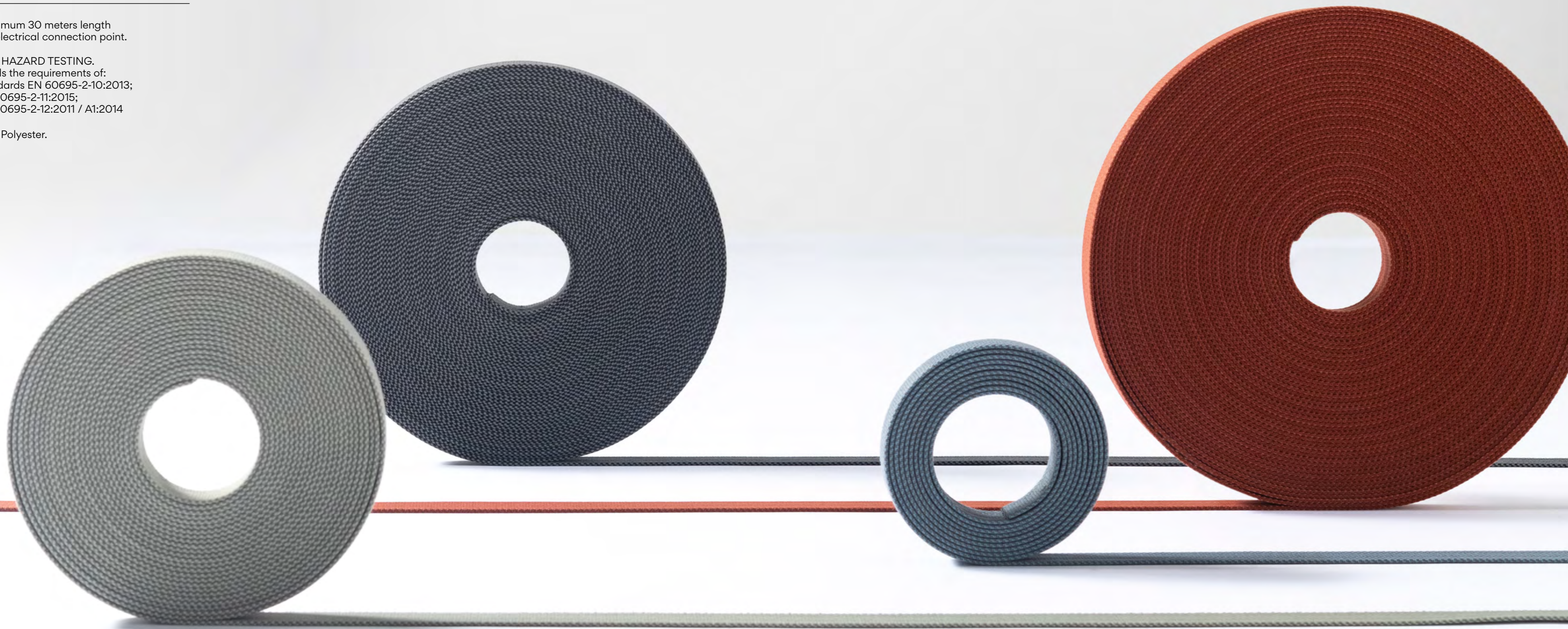



# Luminaires types

- 11 Black (NCS S 8500-N)
- 13 White Grey L1 (NCS S 1000-N)
- 37 Terra Red (NCS S 4040-Y70R)
- 42 Blue M1 (NCS S 5010-B10G)
- 53 Green M1 (NCS S 6005-G80Y)

LED 2700 K / 3000 K / 3500 K. CRI>90

Dimming options:  
On/ Off.  
Simultaneous line DALI, 1-10V, Push, Casambi.  
Casambi integrated on each individual luminaire (P2P).

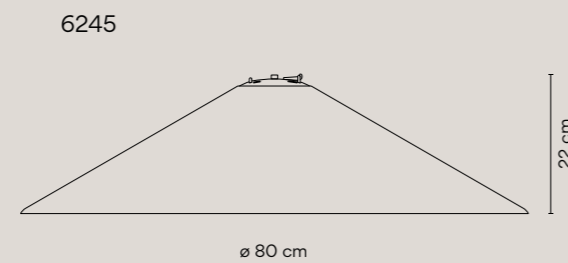
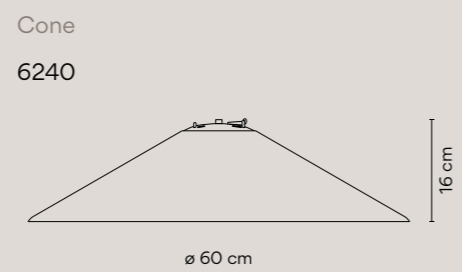
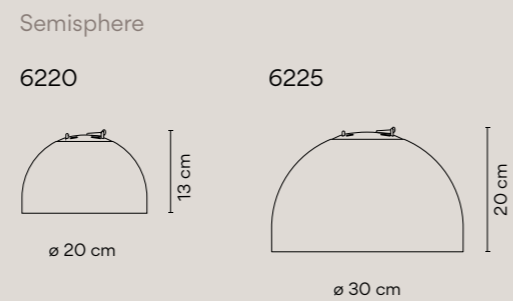
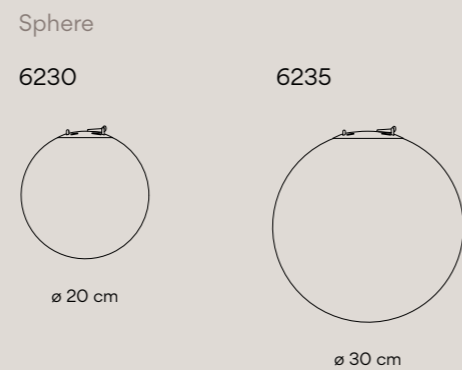

Spotlight

Accent lighting: 6200 (12°), 6205 (24°), 6210 (55°).

Directed diffusion lighting: 6215.

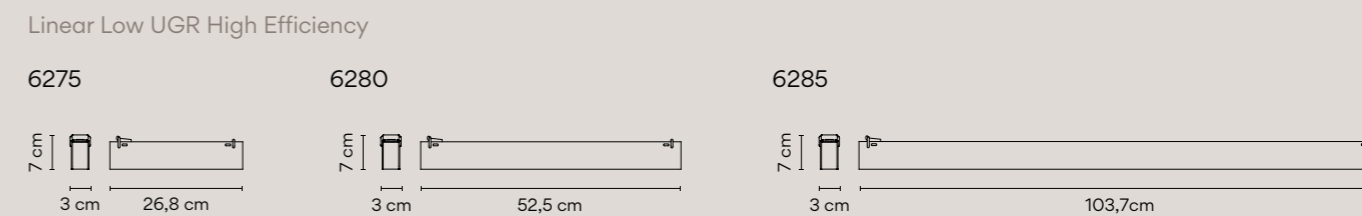
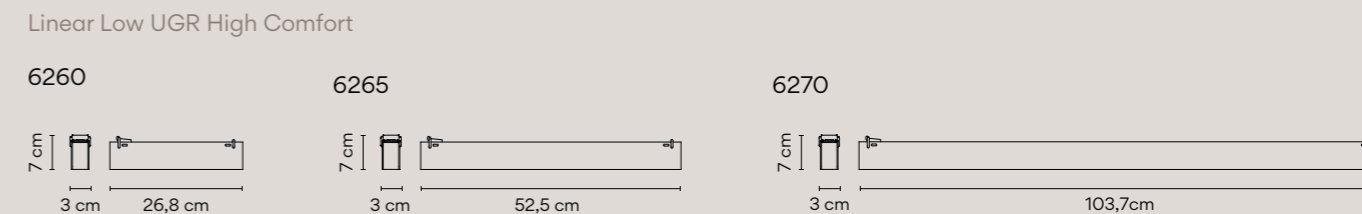
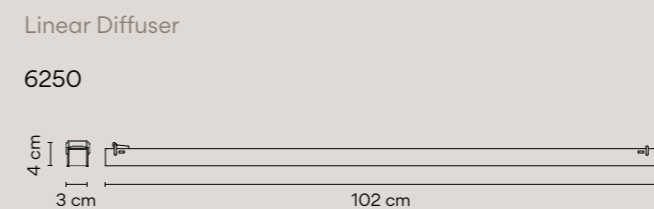
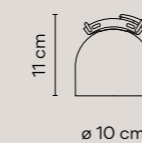

## Sphere

360° Diffusion lighting



Ø 20 cm

6230



Ø 30 cm







6235

**6230**  
1 x LED 7,9 W 450mA.   
LED 2700 K. CRI>90.  
LED 3000 K. CRI>90.  
LED 3500 K. CRI>90.  
846 lm. 107,09 lm/W.

**Dimming Control:**  
On/ Off.  
Simultaneous line DALI, 1-10V, Push, Casambi.  
Casambi integrated on each individual luminaire (P2P).

Body: Aluminum.  
Diffuser: Triplex opal glass.  
Net weight 0,93 Kg.



**6230 11** Black (NCS S 8500-N)   
**6230 13** White Grey L1 (NCS S 1000-N)   
**6230 37** Terra Red (NCS S 4040-Y70R)   
**6230 42** Blue M1 (NCS S 5010-B10G)   
**6230 53** Green M1 (NCS S 6005-G80Y) 







     

**6235**  
1 x LED 16 W 850mA.   
LED 2700 K. CRI>90.  
LED 3000 K. CRI>90.  
LED 3500 K. CRI>90.  
1492 lm. 93,25 lm/W.

**Dimming Control:**  
On/ Off.  
Simultaneous line DALI, 1-10V, Push, Casambi.  
Casambi integrated on each individual luminaire (P2P).

Body: Aluminum.  
Diffuser: Triplex opal glass.  
Net weight 1,80 Kg.

**6235 11** Black (NCS S 8500-N)   
**6235 13** White Grey L1 (NCS S 1000-N)   
**6235 37** Terra Red (NCS S 4040-Y70R)   
**6235 42** Blue M1 (NCS S 5010-B10G)   
**6235 53** Green M1 (NCS S 6005-G80Y) 

## Semisphere

Directed diffusion lighting



Ø 20 cm

6220



Ø 30 cm

6225

**6220**  
1 x LED 7,9 W 450mA.   
LED 2700 K. CRI>90.  
LED 3000 K. CRI>90.  
LED 3500 K. CRI>90.  
846 lm. 107,09 lm/W.

**Dimming Control:**  
On/ Off.  
Simultaneous line DALI, 1-10V, Push, Casambi.  
Casambi integrated on each individual luminaire (P2P).

Shade: Aluminum.  
Diffuser: Polycarbonate.  
Net weight 0,78 Kg.

**6220 11** Black (NCS S 8500-N)   
**6220 13** White Grey L1 (NCS S 1000-N)   
**6220 37** Terra Red (NCS S 4040-Y70R)   
**6220 42** Blue M1 (NCS S 5010-B10G)   
**6220 53** Green M1 (NCS S 6005-G80Y) 

**6225**  
1 x LED 16 W 850mA.   
LED 2700 K. CRI>90.  
LED 3000 K. CRI>90.  
LED 3500 K. CRI>90.  
1492 lm. 93,25 lm/W.

**Dimming Control:**  
On/ Off.  
Simultaneous line DALI, 1-10V, Push, Casambi.  
Casambi integrated on each individual luminaire (P2P).

Shade: Aluminum.  
Diffuser: Polycarbonate.  
Net weight 1,51 Kg.

**6225 11** Black (NCS S 8500-N)   
**6225 13** White Grey L1 (NCS S 1000-N)   
**6225 37** Terra Red (NCS S 4040-Y70R)   
**6225 42** Blue M1 (NCS S 5010-B10G)   
**6225 53** Green M1 (NCS S 6005-G80Y) 

## Cone

## Directed diffusion lighting



Ø 60 cm

6240



Ø 80 cm

6245

## 6240

1 x LED 16 W 850mA.

LED 2700 K. CRI>90.  
LED 3000 K. CRI>90.  
LED 3500 K. CRI>90.  
1492 lm. 93,25 lm/W.

## Dimming Control:

On/ Off.  
Simultaneous line DALI, 1-10V, Push, Casambi.  
Casambi integrated on each individual luminaire (P2P).

Shade: Aluminum.  
Diffuser: Triplex opal glass.  
Net weight 2,5 Kg.

6240 11 Black (NCS S 8500-N)

6240 13 White Grey L1 (NCS S 1000-N)

6240 37 Terra Red (NCS S 4040-Y70R)

6240 42 Blue M1 (NCS S 5010-B10G)

6240 53 Green M1 (NCS S 6005-G80Y)

## 6245

1 x LED 16 W 850mA.

LED 2700 K. CRI>90.  
LED 3000 K. CRI>90.  
LED 3500 K. CRI>90.  
1492 lm. 93,25 lm/W.

## Dimming Control:

On/ Off.  
Simultaneous line DALI, 1-10V, Push, Casambi.  
Casambi integrated on each individual luminaire (P2P).

Shade: Aluminum.  
Diffuser: Triplex opal glass.  
Net weight 3,46 Kg.

6245 11 Black (NCS S 8500-N)

6245 13 White Grey L1 (NCS S 1000-N)

6245 37 Terra Red (NCS S 4040-Y70R)

6245 42 Blue M1 (NCS S 5010-B10G)

6245 53 Green M1 (NCS S 6005-G80Y)

## Linear diffuser

## General lighting

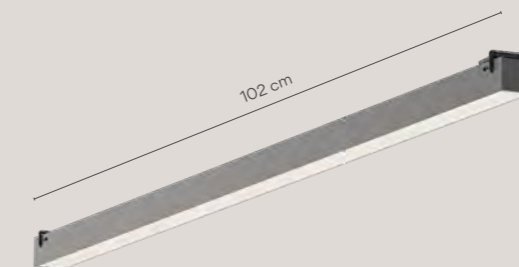

6250



6255

## 6250

1 x LED STRIP 20,6W 24V.

LED 2700 K. CRI>90.  
LED 3000 K. CRI>90.  
LED 3500 K. CRI>90.  
2544 lm. 123,3 lm/W.

## Dimming Control:

On/ Off.  
Simultaneous line DALI, 1-10V, Push, Casambi.  
Casambi integrated on each individual luminaire (P2P).

Shade: Aluminum.  
Diffuser: Polycarbonate.  
Net weight 0,72 Kg.

6250 11 Black (NCS S 8500-N)

6250 13 White Grey L1 (NCS S 1000-N)

6250 37 Terra Red (NCS S 4040-Y70R)

6250 42 Blue M1 (NCS S 5010-B10G)

6250 53 Green M1 (NCS S 6005-G80Y)

## 6255

1 x LED STRIP 41,3 W 24V.

LED 2700 K. CRI>90.  
LED 3000 K. CRI>90.  
LED 3500 K. CRI>90.  
5088 lm. 123,3 lm/W.

## Dimming Control:

On/ Off.  
Simultaneous line DALI, 1-10V, Push, Casambi.  
Casambi integrated on each individual luminaire (P2P).

Shade: Aluminum.  
Diffuser: Polycarbonate.  
Net weight 1,45 Kg.

6255 11 Black (NCS S 8500-N)

6255 13 White Grey L1 (NCS S 1000-N)

6255 37 Terra Red (NCS S 4040-Y70R)

6255 42 Blue M1 (NCS S 5010-B10G)

6255 53 Green M1 (NCS S 6005-G80Y)

# Linear Low UGR

## High Comfort

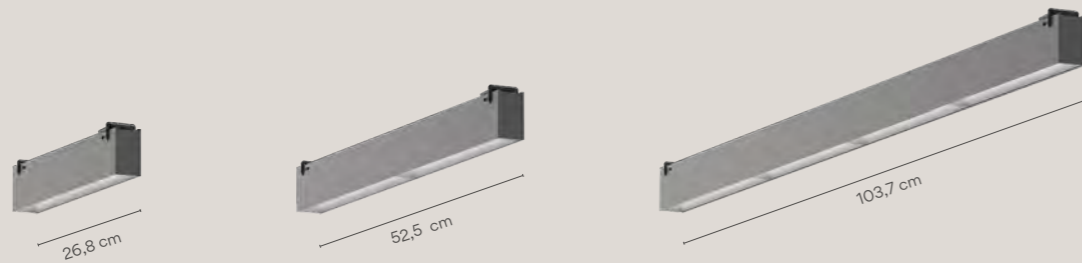
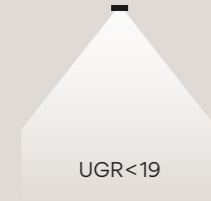

6260

6265

6270

**6260**  
1 x LED STRIP 10,3W 24V.

LED 2700 K. CRI>90.  
LED 3000 K. CRI>90.  
LED 3500 K. CRI>90.  
1366 lm. 132,3 lm/W.

**Dimming Control:**  
On/ Off.  
Simultaneous line DALI, 1-10V, Push, Casambi.  
Casambi integrated on each individual luminaire (P2P).

Shade: Aluminum.  
Diffuser: PET.  
Net weight 0,41 Kg.

- 6260 11 Black (NCS S 8500-N)
- 6260 13 White Grey L1 (NCS S 1000-N)
- 6260 37 Terra Red (NCS S 4040-Y70R)
- 6260 42 Blue M1 (NCS S 5010-B10G)
- 6260 53 Green M1 (NCS S 6005-G80Y)

**6265**  
1 x LED STRIP 20,6W 24V.

LED 2700 K. CRI>90.  
LED 3000 K. CRI>90.  
LED 3500 K. CRI>90.  
2731 lm. 132,3 lm/W.

**Dimming Control:**  
On/ Off.  
Simultaneous line DALI, 1-10V, Push, Casambi.  
Casambi integrated on each individual luminaire (P2P).

Shade: Aluminum.  
Diffuser: PET.  
Net weight 0,89 Kg.

- 6265 11 Black (NCS S 8500-N)
- 6265 13 White Grey L1 (NCS S 1000-N)
- 6265 37 Terra Red (NCS S 4040-Y70R)
- 6265 42 Blue M1 (NCS S 5010-B10G)
- 6265 53 Green M1 (NCS S 6005-G80Y)

**6270**  
1 x LED STRIP 41,3W 24V.

LED 2700 K. CRI>90.  
LED 3000 K. CRI>90.  
LED 3500 K. CRI>90.  
5462 lm. 132,3 lm/W.

**Dimming Control:**  
On/ Off.  
Simultaneous line DALI, 1-10V, Push, Casambi.  
Casambi integrated on each individual luminaire (P2P).

Shade: Aluminum.  
Diffuser: PET.  
Net weight 1,50 Kg.

- 6270 11 Black (NCS S 8500-N)
- 6270 13 White Grey L1 (NCS S 1000-N)
- 6270 37 Terra Red (NCS S 4040-Y70R)
- 6270 42 Blue M1 (NCS S 5010-B10G)
- 6270 53 Green M1 (NCS S 6005-G80Y)

## High Efficiency

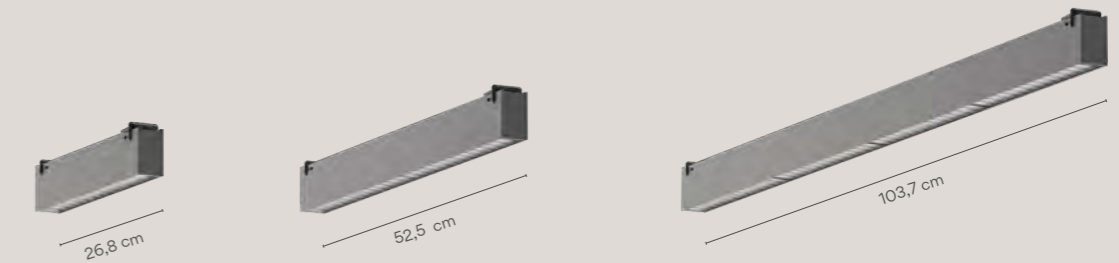

6275

6280

6285

**6275**  
1 x LED STRIP 10,3W 24V.

LED 2700 K. CRI>90.  
LED 3000 K. CRI>90.  
LED 3500 K. CRI>90.  
1366 lm. 132,3 lm/W.

**Dimming Control:**  
On/ Off.  
Simultaneous line DALI, 1-10V, Push, Casambi.  
Casambi integrated on each individual luminaire (P2P).

Shade: Aluminum.  
Net weight 0,41 Kg.

- 6275 11 Black (NCS S 8500-N)
- 6275 13 White Grey L1 (NCS S 1000-N)
- 6275 37 Terra Red (NCS S 4040-Y70R)
- 6275 42 Blue M1 (NCS S 5010-B10G)
- 6275 53 Green M1 (NCS S 6005-G80Y)

**6280**  
1 x LED STRIP 20,6W 24V.

LED 2700 K. CRI>90.  
LED 3000 K. CRI>90.  
LED 3500 K. CRI>90.  
2731 lm. 132,3 lm/W.

**Dimming Control:**  
On/ Off.  
Simultaneous line DALI, 1-10V, Push, Casambi.  
Casambi integrated on each individual luminaire (P2P).

Shade: Aluminum.  
Net weight 0,89 Kg.

- 6280 11 Black (NCS S 8500-N)
- 6280 13 White Grey L1 (NCS S 1000-N)
- 6280 37 Terra Red (NCS S 4040-Y70R)
- 6280 42 Blue M1 (NCS S 5010-B10G)
- 6280 53 Green M1 (NCS S 6005-G80Y)

**6285**  
1 x LED STRIP 41,3W 24V.

LED 2700 K. CRI>90.  
LED 3000 K. CRI>90.  
LED 3500 K. CRI>90.  
5462 lm. 132,3 lm/w.

**Dimming Control:**  
On/ Off.  
Simultaneous line DALI, 1-10V, Push, Casambi.  
Casambi integrated on each individual luminaire (P2P).

Shade: Aluminum.  
Net weight 1,50 Kg.

- 6285 11 Black (NCS S 8500-N)
- 6285 13 White Grey L1 (NCS S 1000-N)
- 6285 37 Terra Red (NCS S 4040-Y70R)
- 6285 42 Blue M1 (NCS S 5010-B10G)
- 6285 53 Green M1 (NCS S 6005-G80Y)

# Spotlight

## Accent lighting

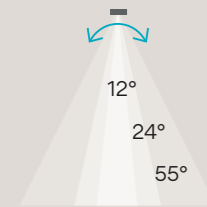

12°



6200

Medium flood 24°



6205

Wide flood 55°

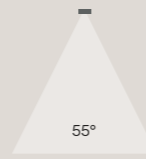

6210



Ø 10 cm

6200



Ø 10 cm

6205 6210

**6200**  
1 x LED 7,9 W 450mA.   
LED 2700 K. CRI>90.  
LED 3000 K. CRI>90.  
LED 3500 K. CRI>90.  
916 lm. 115,95 lm/W.

**Dimming Control:**  
On/ Off.  
Simultaneous line DALI, 1-10V, Push, Casambi.  
Casambi integrated on each individual luminaire (P2P).

Shade: Aluminum.  
Diffuser: Polycarbonate.  
Net weight 0,51 Kg.

- 6200 11** Black (NCS S 8500-N)
- 6200 13** White Grey L1 (NCS S 1000-N)
- 6200 37** Terra Red (NCS S 4040-Y70R)
- 6200 42** Blue M1 (NCS S 5010-B10G)
- 6200 53** Green M1 (NCS S 6005-G80Y)

**6205**  
1 x LED 7,9 W 450mA.   
LED 2700 K. CRI>90.  
LED 3000 K. CRI>90.  
LED 3500 K. CRI>90.  
916 lm. 115,95 lm/W.

**Dimming Control:**  
On/ Off.  
Simultaneous line DALI, 1-10V, Push, Casambi.  
Casambi integrated on each individual luminaire (P2P).

Shade: Aluminum.  
Diffuser: Polycarbonate.  
Net weight 0,51 Kg.

- 6205 11** Black (NCS S 8500-N)
- 6205 13** White Grey L1 (NCS S 1000-N)
- 6205 37** Terra Red (NCS S 4040-Y70R)
- 6205 42** Blue M1 (NCS S 5010-B10G)
- 6205 53** Green M1 (NCS S 6005-G80Y)

**6210**  
1 x LED 7,9 W 450mA.   
LED 2700 K. CRI>90.  
LED 3000 K. CRI>90.  
LED 3500 K. CRI>90.  
916 lm. 115,95 lm/W.

**Dimming Control:**  
On/ Off.  
Simultaneous line DALI, 1-10V, Push, Casambi.  
Casambi integrated on each individual luminaire (P2P).

Shade: Aluminum.  
Diffuser: Polycarbonate.  
Net weight 0,51 Kg.

- 6210 11** Black (NCS S 8500-N)
- 6210 13** White Grey L1 (NCS S 1000-N)
- 6210 37** Terra Red (NCS S 4040-Y70R)
- 6210 42** Blue M1 (NCS S 5010-B10G)
- 6210 53** Green M1 (NCS S 6005-G80Y)

## Directed diffusion lighting

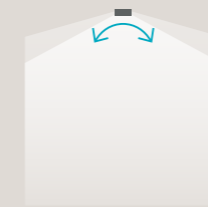

Ø 10 cm

6215

**6215**  
1 x LED 4,2 W 250mA.   
LED 2700 K. CRI>90.  
LED 3000 K. CRI>90.  
LED 3500 K. CRI>90.  
491 lm. 116,9 lm/W.

**Dimming Control:**  
On/ Off.  
Simultaneous line DALI, 1-10V, Push, Casambi.  
Casambi integrated on each individual luminaire (P2P).

Shade: Aluminum.  
Diffuser: Polycarbonate.  
Net weight 0,51 Kg.

- 6215 11** Black (NCS S 8500-N)
- 6215 13** White Grey L1 (NCS S 1000-N)
- 6215 37** Terra Red (NCS S 4040-Y70R)
- 6215 42** Blue M1 (NCS S 5010-B10G)
- 6215 53** Green M1 (NCS S 6005-G80Y)

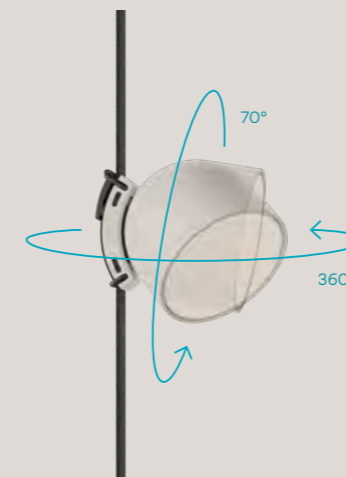

## Electrical Connection options

Choose your preferred installation option according to your needs.



Surface      Built-in      Remote      Plug      Optional wire connector

## Dimming Control options

Dimming Control	Electrical Connection			
	Surface 25 - 240 W	Built-in 25 - 240 W	Remote 25 - 240 W	Plug Max 60W
On / Off	✓	✓	✓	✓
Push Switch	—	—	—	✓
Push Simultaneous	✓	✓	✓	—
1-10V Simultaneous	✓	✓	✓	—
DALI Simultaneous	✓	✓	✓	—
Casambi Simultaneous	✓	✓	✓	—
Casambi integrated on each individual luminaire (P2P)	✓	✓	✓	✓

## Belt terminations

Belt terminations can be adjusted during the installation process according to your preference.

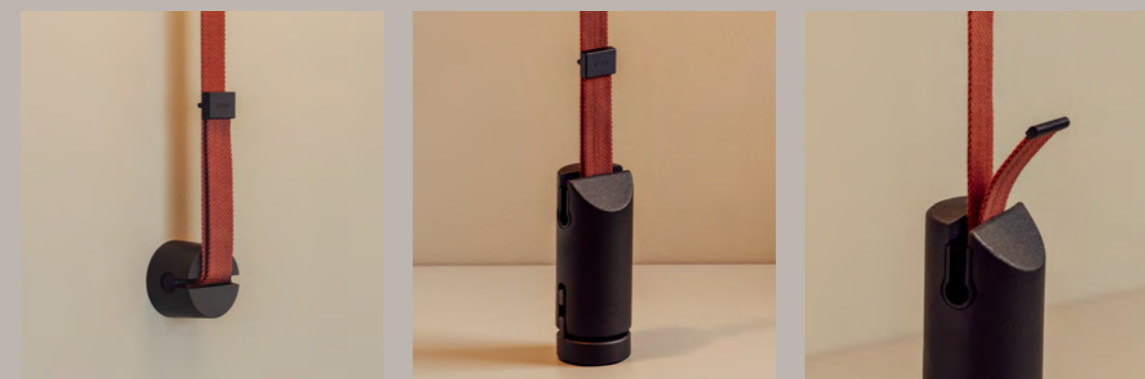
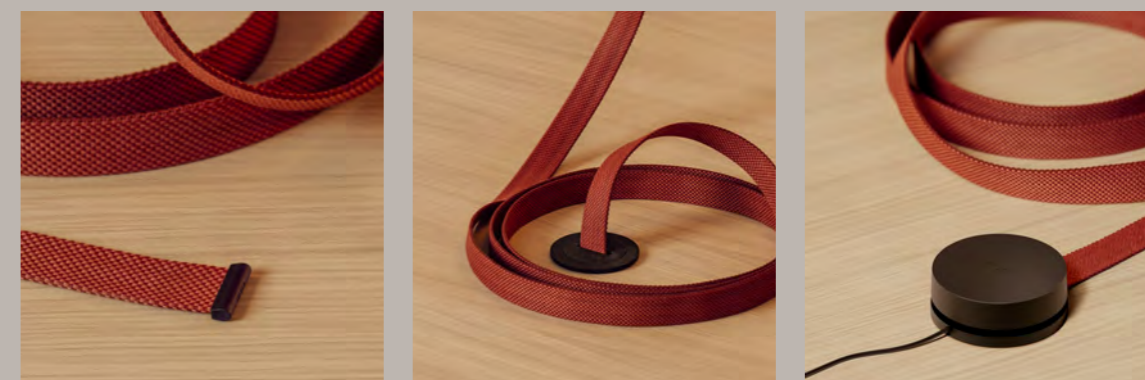
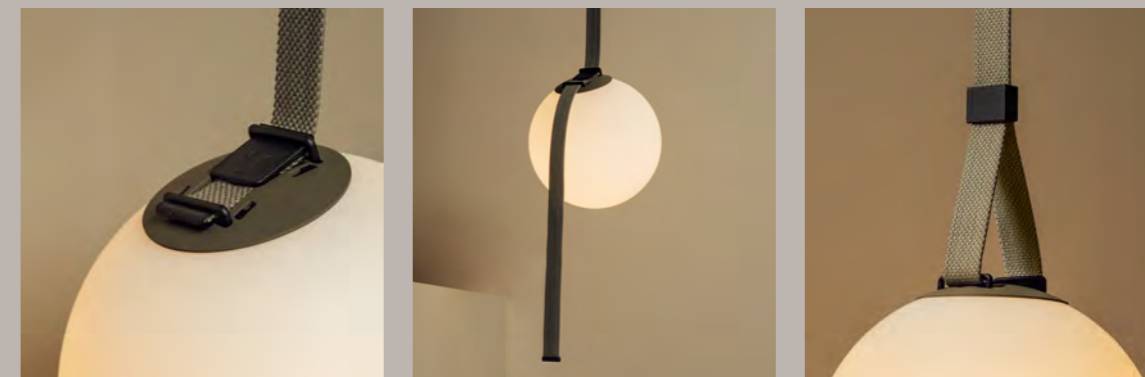

## Easy to design and install

Compose a personalised Plusminus  
at [vibia.com](http://vibia.com)

### From scratch

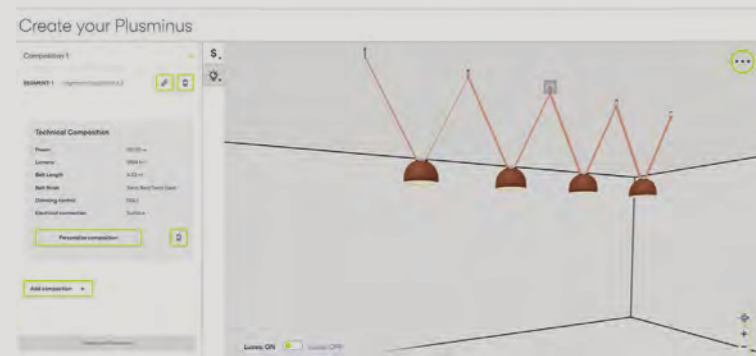

- + Create and compose projects in detail.
- + Draw and personalise in 3D to see it in space.
- + Or personalise it step by step without drawing.

### From of a layout

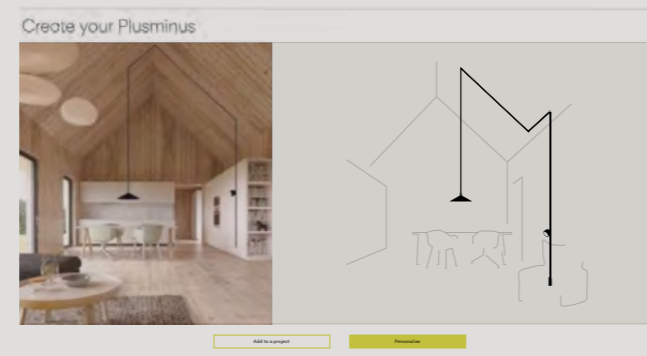

- + Personalise and adapt it to the needs of your project.
- + Add it to your project and edit it at any time.
- + More than 100 creations for you.

## Accessories Toolbox

Thought out to the smallest detail.  
Receive your personalised accessories toolbox  
for a quick and easy installation.







## ACKNOWLEDGEMENTS

Barozzi Veiga  
Photography: Mariela Apollonio  
(page 41)

Photography: Emily Gilbert  
(page 54)

Photography: Filippo Poli  
(page 55)

Photography & Architecture:  
Simón García  
(page 65)

Photography: Dieter Muenchen  
(page 79)

Architecture: BAAS arquitectura  
(page 82, 83)

Architecture: Carles Enrich  
Photography: Adrià Goula  
(page 133)

The content of this catalogue may be changed  
or cancelled at the discretion of the VIBIA  
management without prior notice.

Vibia Lighting, S.L.U.

Spain & Portugal T. +34 934 796 970

International T. +34 934 796 971

hello@vibia.com

www.vibia.com



Plusminus<sup>+ -</sup>

Create unique atmospheres at [vibia.com](http://vibia.com)

